

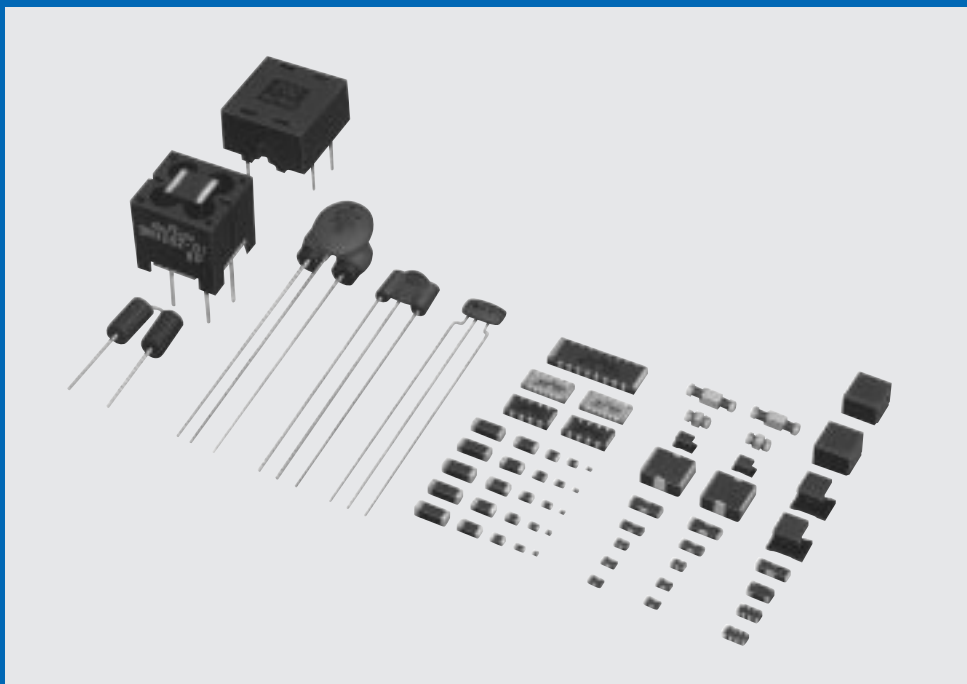

# On-Board Type (DC) EMI Suppression Filter (EMIFIL®)

## EMI SUPPRESSION FILTERS



Murata EMC Solutions : <http://www.murata.co.jp/emc/>



*Innovator  
in Electronics*

Murata  
Manufacturing Co., Ltd.

[www.DataSheet4U.com](http://www.DataSheet4U.com)

Cat.No.C31E-5

MURATA entered the suppression filter field at an early stage in response to serious problems stemming from electromagnetic interference between electronic equipment. These pioneering efforts in the filter field resulted in the development and world-wide marketing of the EMI Suppression Filter (EMIFIL®).

In 1979, MURATA successfully developed an on-board type EMIFIL®, thereby realizing a solution to PC board noise suppression.

In 1985, the EMIFIL® class of on-board filters were further developed to produce a chip-based EMI suppression filter, thus substantially improving noise suppression in compact electronic equipment.

Based on more than thirty years of ceramic dielectric and ferrite technology experience, MURATA's full range of high-performance EMIFIL® serve to overcome and control all types of electronic-equipment noise problems. Further, MURATA's various noise suppression circuits, designed for the diversified needs of the electronic industry, offer great advantages in the pursuit of noise-free equipment, etc.

Currently, MURATA is completing a system for the analysis and solution of noise problems. For the finest in noise suppression components, boards, and related equipment contact the nearest MURATA sales office.

#### ■ABOUT OPERATING CONDITION

Noise suppression levels resulting from MURATA's EMI suppression filters (EMIFIL®) may vary, depending on the circuits and ICs used, type of noise, mounting pattern, lead wire length, mounting location, and other operating conditions. Be sure to check and confirm, in advance, the noise suppression effect of each filter, in actual circuit, etc., before applying the filter in a commercial-purpose equipment design.

EMIFIL® for both DC and AC power supplies, and thru-type EMI suppression filters for high-frequency equipment (thru-type EMIFIL®) are available. For details, contact the nearest MURATA sales office.

# INDEX

www.DataSheet4U.com

## Introduction of EMI Suppression Filter (EMIFIL®)

- Products Guide of EMI Suppression Filter (EMIFIL®) Chip Varistor for DC line ..... 3-5
- Selection Guide of CHIP EMIFIL® ..... 6
- Typical Application of EMI Suppression Filter (EMIFIL®) for DC line ..... 7-8
- Outlines of EMI Suppression Filter (EMIFIL®) for DC line ..... 9-12

1

## Chip EMI Suppression Filter (EMIFIL®)/Chip Varistor

- Chip Ferrite Bead BLM10/11/21/31/41 Series ..... 13-34
- Chip Ferrite Beads for GHz Range Noise Suppression BLM11H□ Series ..... 35-36
- Chip Ferrite Bead Array BLA3216 Series ..... 37-38
- Chip Solid EMIFIL® NFM2012R/40R/3212R/41R/4516R Series ..... 40-42
- Chip EMIFIL® Array NFA81R/62R/3216D Series ... 43-44
- Chip EMIFIL® Array NFA3216G Series ..... 45-46
- Chip EMIFIL® NFM839R Series ..... 47-50
- Chip EMIFIL® for Signal line NFM51R Series ..... 51-53
- Chip Solid EMIFIL® NFM2012P/40P/4516P/46P Series ..... 54-55

- T-type Chip EMIFIL® NFM60R/61R/61RH Series ... 56-57
- Chip Solid EMIGUARD® VFM41R Series ..... 58-59
- Chip Common Mode Choke Coil PLP3216S Series ... 60-61
- Chip Common Mode Choke Coil PLM3216K ..... 62-63
- Chip Common Mode Choke Coil PLW3216S Series ... 64-65
- Chip Common Mode Choke Coil PLM250H/250S Series ..... 66-67
- Chip Varistor VCM11R/21R Series ..... 68-69
- Notice of Chip EMIFIL®/Chip Varistor ..... 70-76
- Tape Dimensions of Chip EMIFIL®/Chip Varistor ..... 77

2

## Lead Type EMI Suppression Filter (EMIFIL®)

- Ferrite Bead Inductor BL01/02/03 Series ..... 78-79
- Disk Type DS□306/DS□310/DS□310H Series ..... 80-85
- EMIGUARD® VFR303/DSS706/710 Series ..... 86-92
- EMIFIL® For Automatic Insertion ..... 93-96

- Block Type BNP/BNX Series ..... 97-100
- DC Common Mode Choke Coil PLT/PLT09H Series ..... 101-102
- Notice of Lead Type EMIFIL® ..... 103

3

## EMC Absorber

- EA10/20/21 Series ..... 104

4

## EMI Suppression Filter (EMIFIL®) Design Kit

- EMIFIL® Design Kits EK115E/015D ..... 105-107
- Chip EMIFIL® Design Kits EKEM11UB/12UC/13UA/14UA ... 108-109

5

## Explanation

- Outlines of Major Noise Regulation Standards ... 110-114
- Noise Suppression Principles by DC EMIFIL® ... 115-116
- Murata EMI Filter Section Simulator ..... 117





















6

Products Guide of EMI Suppression Filter (EMIFIL®)/Chip Varistor for DC line

www.DataSheet4U.com

1























■ PRODUCTS GUIDE

Inductor Type	Type	Series	Dimensions		Effective Frequency Range						Page	
			(mm)	EIA Code	10kHz	100kHz	1MHz	10MHz	100MHz	1GHz		10GHz
Inductor Type	For Digital Interface 	BLM11R	1.6 ■ ±0.8	0603								13-39
		BLM21R 	2.0 ■ ±1.25	0805								
	Standard Type 	BLM10A 	1.0 ■ ±0.5	0402								
		BLM11A 	1.6 ■ ±0.8	0603								
		BLM21A 	2.0 ■ ±1.25	0805								
		BLM31A 	3.2 ■ ±1.6	1206								
		BLM41A 	4.5 ■ ±1.6	1806								
		BLA3216A (4 circuits array) 	3.2 ■ ±1.6	1206								
	For High Speed Signal 	BLM10B 	1.0 ■ ±0.5	0402								
		BLM11B 	1.6 ■ ±0.8	0603								
		BLM21B 	2.0 ■ ±1.25	0805								
		BLM31B 	3.2 ■ ±1.6	1206								
		BLA3216B (4 circuits array) 	3.2 ■ ±1.6	1206								
	For Large Current 	BLM11P 	1.6 ■ ±0.8	0603								
		BLM21P 	2.0 ■ ±1.25	0805								
BLM31P 		3.2 ■ ±1.6	1206									
BLM41P 		4.5 ■ ±1.6	1806									
For GHz Range Noise Suppression 	BLM11HA	1.6 ■ ±0.8	0603									
	BLM11HB	1.6 ■ ±0.8	0603									

Products Guide of EMI Suppression Filter (EMIFIL®)/Chip Varistor for DC line

www.DataSheet4U.com





1

Type	Series	Dimensions		Effective Frequency Range						Page		
		(mm)	EIA Code	10kHz	100kHz	1MHz	10MHz	100MHz	1GHz		10GHz	
Capacitor Type	Standard Type	NFM2012R		0805								40-42
		NFM40R/3212R		1205								
		NFM41R/4516R		1806								
		NFA81R (8 circuits array)		5018								43-44
		NFA62R (6 circuits array)		2512								
		NFA3216D (4 circuits array)		1206								
	For Signal Line	NFM839R		0805								47-50
		NFA3216G (4 circuits array)		1206								45-46
		NFM51R		1206								51-53
	For Large Current	NFM2012P		0805								54-55
		NFM40P		1205								
		NFM4516P		1806								
NFM46P			2220									
T Filter for Large Current	NFM60R		1206								56-57	
	NFM61R (H)		2706									
With Varistor Function	VFM41R		1806								58-59	
Common Mode Choke Coil	PLP3216S		1206								60-61	
	PLM3216K		1206								62-63	
	PLW3216S		1206								64-65	
	PLM250S (PLM250H)		2020 (2014)								66-67	
Chip Varistor	VCM11R		0603								68-69	
	VCM21R		0805									

Products Guide of EMI Suppression Filter (EMIFIL®)/Chip Varistor for DC line

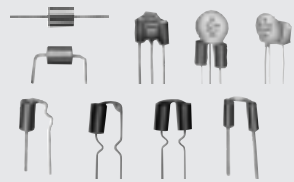
www.DataSheet4U.com

1

Type	Series	Dimensions		Effective Frequency Range							Page	
		(mm)	EIA Code	10kHz	100kHz	1MHz	10MHz	100MHz	1GHz	10GHz		
Disc Type EMIFIL® 	BL01/02/03 DS-306/310 (H)											78-85
EMIGUARD® 	VFR303 DSS706/710											86-92
Block Type EMIFIL® 	BNP/BNX											97-100
Common Mode Choke Coil 	PLT/PLT09H											101-102
EMC Absorber 	EA10/20/21											104

# Selection Guide of CHIP EMIFIL®

1

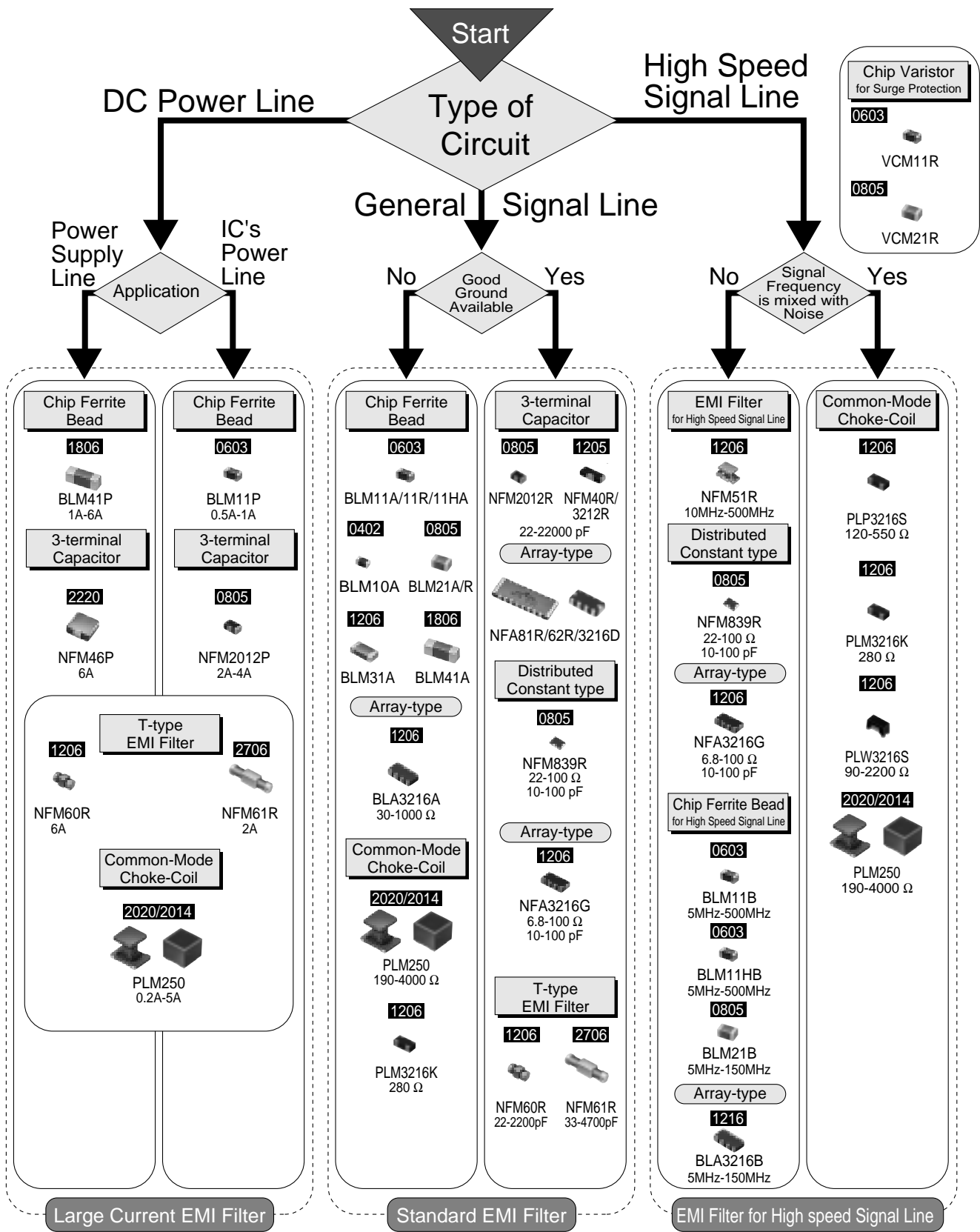

Impedance is typical value at 100MHz

## Typical Application of EMI Suppression Filter (EMIFIL®) for DC line

www.DataSheet4U.com

1

The main applications of EMIFIL® for DC lines are as follows: Descriptions of these applications are based on standard digital PC board.

Typical applications of EMIFIL® in PC boards can be divided into four types:

### 1. Elimination of non desirable harmonics in high speed signal lines

High speed clock signals, for example, contain higher level harmonic components, which can cause noise. These higher harmonics are reduced to within acceptable range by EMIFIL®.

For relatively low noise levels, chip ferrite bead inductors and chip solid EMIFIL® (3-terminal capacitors) are used; for high level noise applications, signal line EMIFIL® are used.

### 2. Elimination of noise in DC power supplies

DC power supplies utilize high frequency current in converting AC power to DC power, etc., and these currents may cause noise. Since DC power supplies are designed to supply only DC current, the current flow is larger than that on the signal lines, which can cause DC resistance. Therefore, in such situations, EMIFIL® having a wider noise suppression band and larger current capacity are used. For relatively low noise suppression, chip ferrite bead inductors and chip solid EMIFIL® (3-terminal capacitors) are used; block-type, DC power supply EMIFIL® are used to suppress higher level noise.

### 3. Noise suppression in I/O cables

Some I/O cables, when connected to PC boards, act as an excellent antenna, which can radiate noise and induce noise through coupling. To prevent this, EMIFIL® are used at the connection point between the I/O cable and PC board to prevent noise from being introduced into the board. For relatively low level noise suppression, chip ferrite bead inductors are used; for high noise suppression, chip solid EMIFIL® (3-terminal capacitors) are used. At high speed signal line connection points, signal line EMIFIL® are used.

### 4. High voltage surge countermeasures

EMIGUARD® filters, which also have a surge absorbing function (using a varistor), are effective in preventing both higher harmonic noise and high voltage surges (such as electrostatic discharges) from interfering with PC board operation.

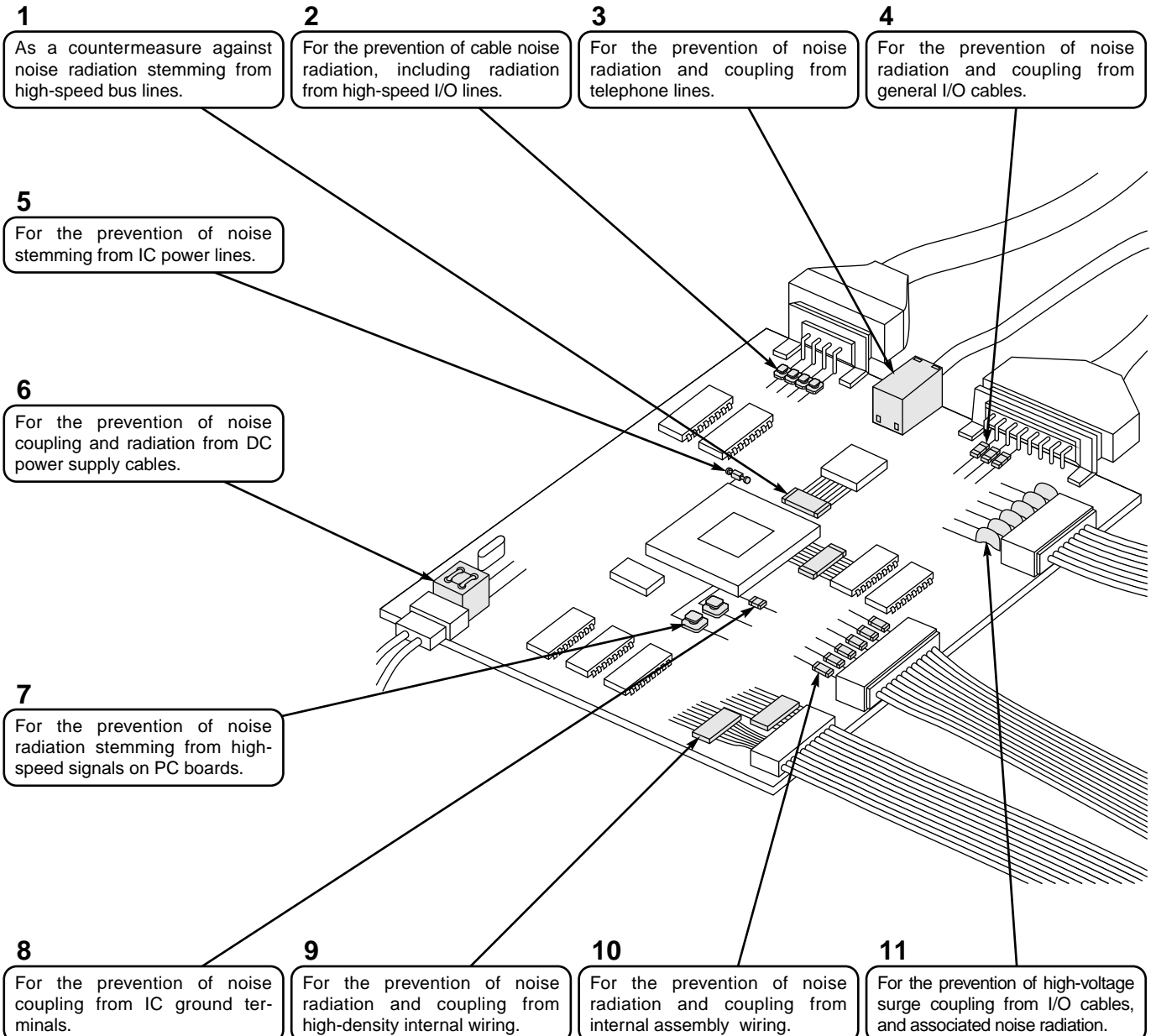



**Typical Application of EMI Suppression Filter (EMIFIL®) for DC line**

www.DataSheet4U.com

1

		<b>EMI Countermeasure</b>	<b>Suitable EMIFIL® .....Page</b>
<b>1</b>	As a countermeasure against noise radiation stemming from high-speed bus lines.	High-density mounting EMIFIL® are used in bus line circuitry designs.	Chip Ferrite Bead .....13-36 Chip Ferrite Bead Array .....37-39 Chip EMIFIL® Array .....45-46
<b>2</b>	For the prevention of cable noise radiation, including radiation from high-speed I/O lines.	High-performance EMIFIL® are also used in signal applications.	Chip EMIFIL® for Signal Line ...51-53 Common Mode Choke Coil .....60-67 101-102
<b>3</b>	For the prevention of noise radiation and coupling from telephone lines.	Common Mode Choke Coil used.	Common Mode Choke Coil .....60-67 101-102
<b>4</b>	For the prevention of noise radiation and coupling from general I/O cables.	EMIFIL® are used in each I/O cable/PC Board connection point.	Chip Solid EMIFIL® .....40-42 Disk Type EMIFIL® .....80-85
<b>5</b>	For the prevention of noise stemming from IC power lines.	EMIFIL® are inserted into the IC power circuitry.	Chip EMIFIL® for Power Line...54-55 T-type Chip EMIFIL® .....56-57 Ferrite Bead Inductor .....78-79 Disk Type EMIFIL® .....80-85
<b>6</b>	For the prevention of noise coupling and radiation from DC power supply cables.	DC power supply wide-band EMIFIL® are used in the power supply circuitry section.	Common Mode Choke Coil .....101-102 T-type Chip EMIFIL® .....56-57 Block Type .....97-100 Disk Type EMIFIL® .....80-85
<b>7</b>	For the prevention of noise radiation stemming from high-speed signals on PC boards.	High-speed signal EMIFIL® are used in the appropriate circuit.	Chip EMIFIL® for Signal Line ...51-53
<b>8</b>	For the prevention of noise coupling from IC ground terminals.	An inductor is inserted into the ground terminal.	Chip Ferrite Bead .....13-36 Ferrite Bead Inductor .....78-79
<b>9</b>	For the prevention of noise radiation and coupling from high-density internal wiring.	High-density EMIFIL® are used in the circuits connected to high-density wiring.	Chip EMIFIL® Array .....43-44
<b>10</b>	For the prevention of noise radiation and coupling from internal assembly wiring.	EMIFIL® are inserted into circuits connected to the wiring.	Chip Solid EMIFIL® .....40-42 Disk Type EMIFIL® .....80-85
<b>11</b>	For the prevention of high-voltage surge coupling from I/O cables, and associated noise radiation.	EMIGUARD® filters or chip varistor are inserted between the board and the cable connecting point.	Chip Varistor .....68-69 Chip Solid EMIGUARD® .....58-59 EMIGUARD® .....86-92

**Outlines of EMI Suppression Filter (EMIFIL®) for DC line**

www.DataSheet4U.com

**Chip Ferrite Bead/Ferrite Bead Inductor**

Chip Ferrite Bead .....P.13-39



Ferrite Bead Inductor .....P.78-79

- Inductor type EMI suppression filters are effective for frequencies ranging from a few MHz to a few GHz. Inductor type filters are small, lightweight, and widely used as a low noise countermeasure, as well as a universal noise suppression component.
- The inductor type EMIFIL® produce a micro inductance in the low frequency range. At high frequencies, however, the resistive component of the inductor produces the primary impedance. When inserted in series in the noise producing circuit, the resistive impedance of the inductor prevents noise propagation.

Equivalent Circuit

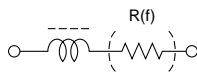

**■ IMPEDANCE-FREQUENCY CHARACTERISTICS (TYPICAL)**

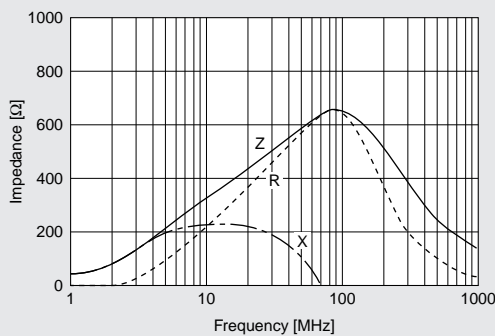

R : Real Part (Resistive Portion) X : Imaginary Part (Inductive Portion)

**Chip Solid EMIFIL® /T-Type Chip EMIFIL® /Disk Type EMIFIL®**

Chip Solid EMIFIL® .....P.40-44

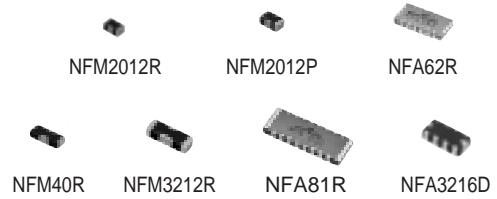

T-type Chip EMIFIL® .....P.56-57



Disk Type EMIFIL® .....P.80-85

- This capacitor type EMI suppression filter has a large noise suppression effect at frequencies ranging from a few MHz to hundreds of MHz. This type of filter is used widely as a universal, high performance EMI suppression component.
- The chip solid EMIFIL® incorporates a built-in three-terminal capacitor, eliminating the lead wire and thereby increasing the high-frequency performance characteristic.
- The T-type chip EMIFIL® is a chip EMI suppression filter with a built-in feed-thru capacitor. The use of ferrite beads on input and output terminals minimizes resonance with surrounding circuits.
- Whatever the situation, 3-terminal construction reduces residual inductance, thereby substantially improving noise suppression at frequencies over 10MHz.

**■ COMPARISON OF INSERTION LOSS CHARACTERISTICS**

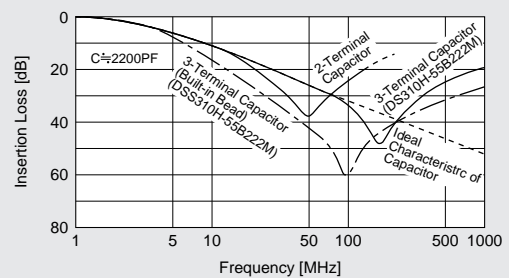

A 3-terminal capacitor has a high self resonance frequency than general 2-terminal type and exhibits effective noise suppression at high frequency

## Outlines of EMI Suppression Filter (EMIFIL®) for DC line

www.DataSheet4U.com

1

### EMIFIL® for Signal Line

Chip EMIFIL® for Signal Line..... P.13-32, P.51-53

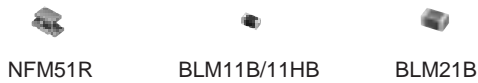

Chip EMIFIL® with Waveform Distortion Suppressing Function.....P.45-50

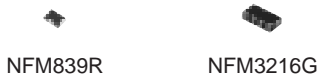

- High-speed signal application EMIFIL® are high performance EMI suppression filters which increase the slope of insertion loss frequency characteristic curves (shape factor), thereby improving noise and signal separation. These are used for high speed signal applications in which noise and signal frequency approach the same value.  
To avoid the elimination of both the noise and specific signal components, 3-terminal capacitors and other components are applied.  
An NFM51R with a built-in capacitor and an inductor type BLM□□B are available.  
BLM11HB has additional performance for suppressing GHz range noise after cut off frequency.
- The EMIFIL® with waveform distortion suppressing function suppresses waveform distortion caused by the resonance of digital ICs and surrounding circuits.

### ■ COMPARISON OF INSERTION LOSS CHARACTERISTICS

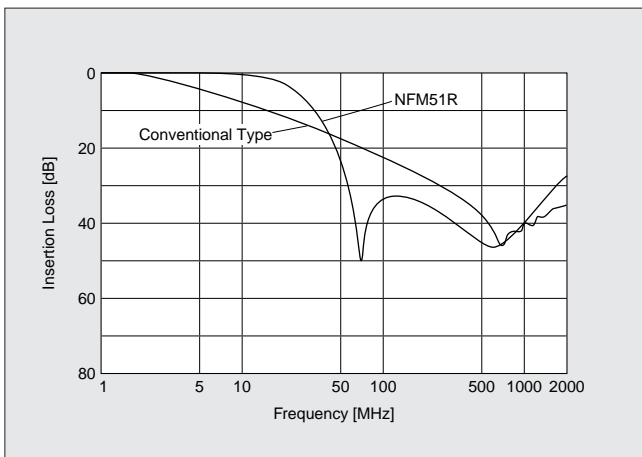

### ● Waveform change when filter is inserted

● Conventional Type

● EMIFIL® for Signal Line NFM51R series

### Common Mode Choke Coil

Chip Common Mode Choke Coil.....P.60-67



Common Mode Choke Coil .....P.101-102

- These choke coils reduce common mode noise, which causes problems on balanced transmission lines, and are effective against common mode noise in the several MHz to several 100 MHz frequency range.  
They are ideally suited for use on DC power supply lines and interface cables.
- There are two types of chip common mode choke coils: the high-performance wound wire PLM250. They offer particular characteristics to match the specific application.

#### Construction of Common Mode Choke Coil

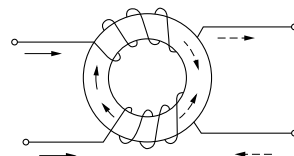

→ Current of Common Mode (Noise)  
- - - Current of Differential Mode (Signal)

#### Equivalent Circuit

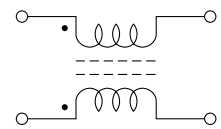

### ■ IMPEDANCE-FREQUENCY CHARACTERISTICS (PLW3216S)

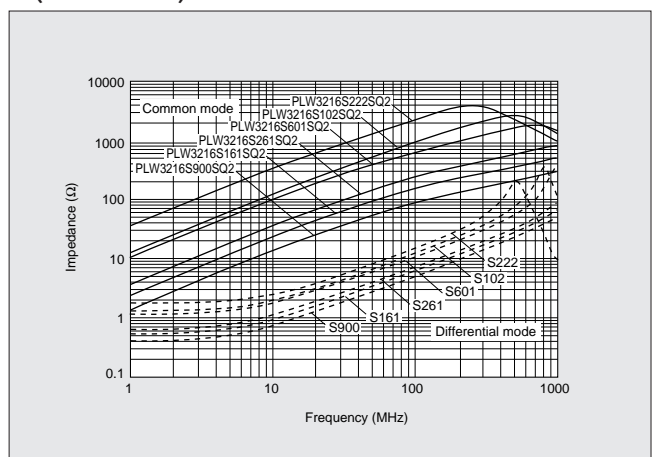

**Outlines of EMI Suppression Filter (EMIFIL®) for DC line**

www.DataSheet4U.com

1

**Chip Varistor**

Chip Varistor .....P.68-69



- Chip varistor is surge absorbing components by inserting surge entrance line and ground line. ESD (Electro Static Discharge) breaks IC inside of equipment. Chip varistor suppress surge voltage and results to protect circuits.
- Chip varistor has twice IC protection performance as zener diode or diode.

**■ SURGE PROTECTION PERFORMANCE**

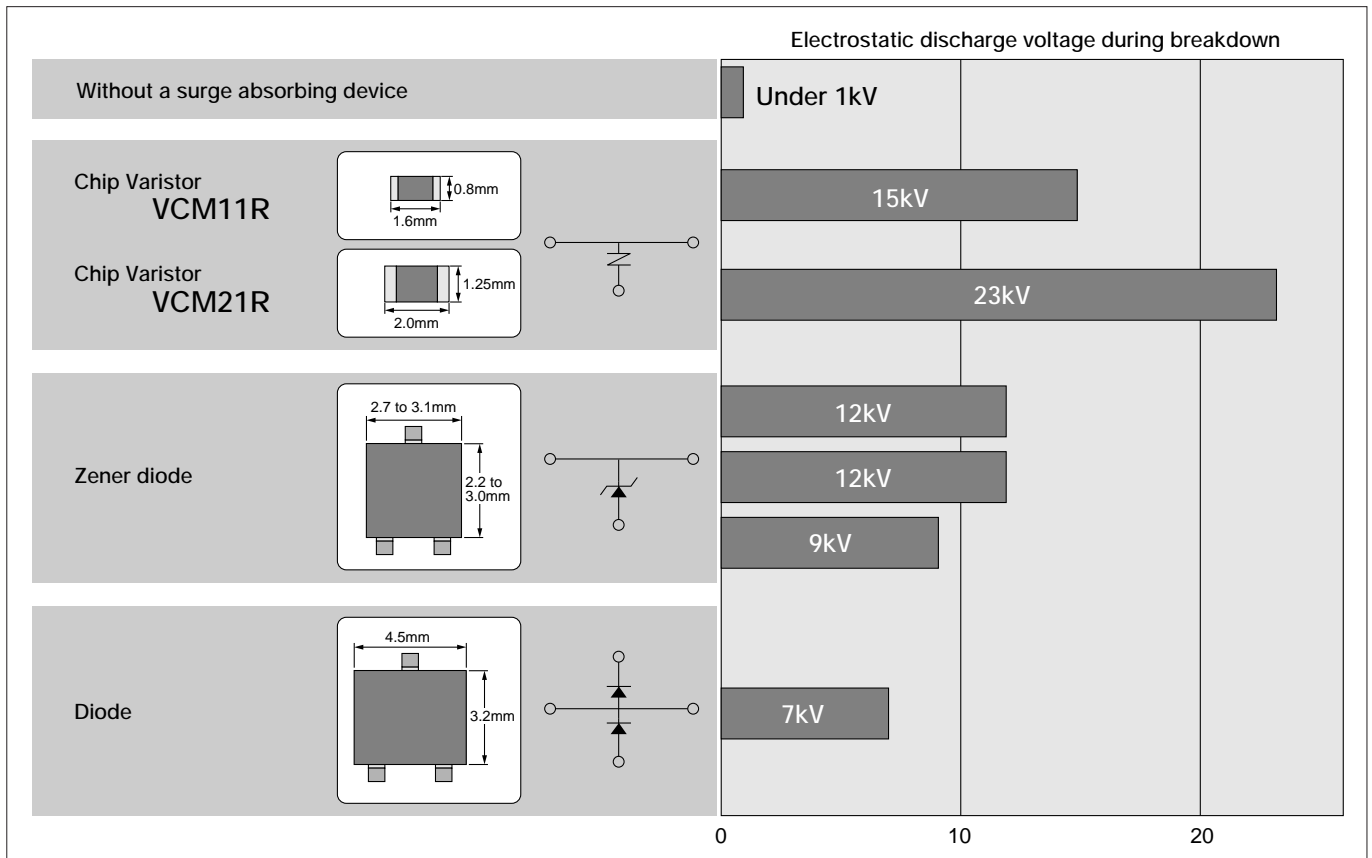

**Surge Test Circuit**

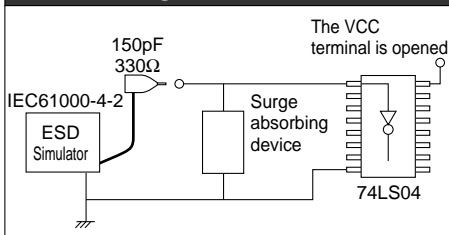

## Outlines of EMI Suppression Filter (EMIFIL®) for DC line

www.DataSheet4U.com

### EMIGUARD®

Chip Solid EMIGUARD® .....P.58-59



EMIGUARD® .....P.86-92

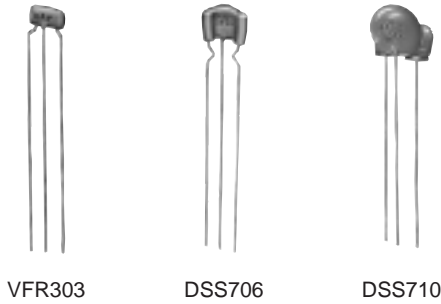

- EMIGUARD® eliminates both surge noises and EMI noises due to its dielectric varistor material.
- Effective when high frequency noise and high voltage surge suppression are required, and also in situations when surging starts at extremely high speeds. This type of surging cannot be eliminated with general type varistors.
- VFM41R is chip type of EMIGUARD®.

#### Construction of EMIGUARD® (DSS710)

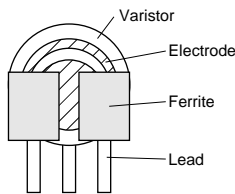

#### ■ SURGE ABSORPTION EFFECT OF EMIGUARD®

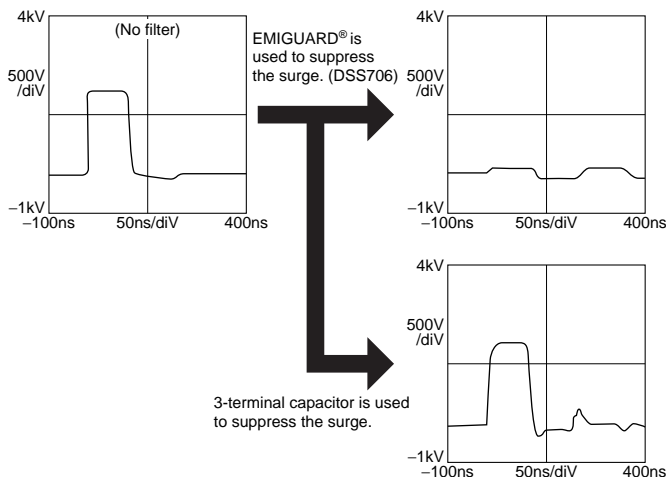

### Block Type EMIFIL®

Block Type EMIFIL® .....P.97-100



- Block type EMIFIL® are resin encased, built-in, high performance EMI suppression filters, which use a feed-thru capacitor having excellent high frequency characteristics.
- Used when the noise frequency is high, or when extreme countermeasures are required.
- The BNP filter series features high performance filters, which are used to suppress noise with frequencies greater than several megahertz in signal circuits. With a current capacity of up to 10A, however, this filter can also be used in DC power circuits (available with 2 or 3 circuits per block).
- The high performance EMIFIL® BNX series exhibits significant noise suppression effects over a wide frequency band (extending from 100kHz to 1GHz) in DC power lines.

#### Equivalent Circuit (BNP Series)

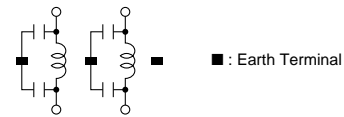

#### Equivalent Circuit (BNX Series)

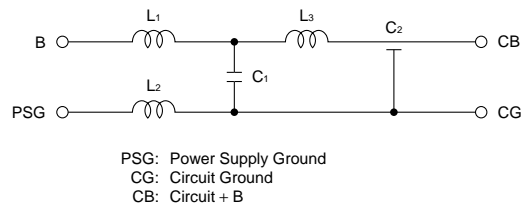

#### ■ INSERTION LOSS CHARACTERISTICS (BNX SERIES)

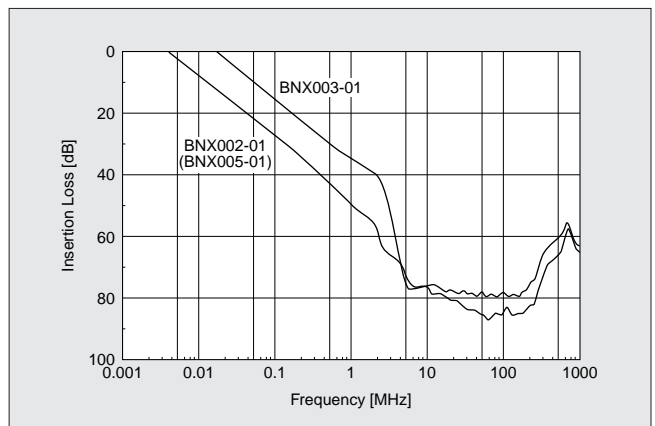



SELECTION GUIDE

www.DataSheet4U.com ●BLM□□A series-Standard · BLM□□R series-For Digital Interface · BLM□□P series-For Large Current

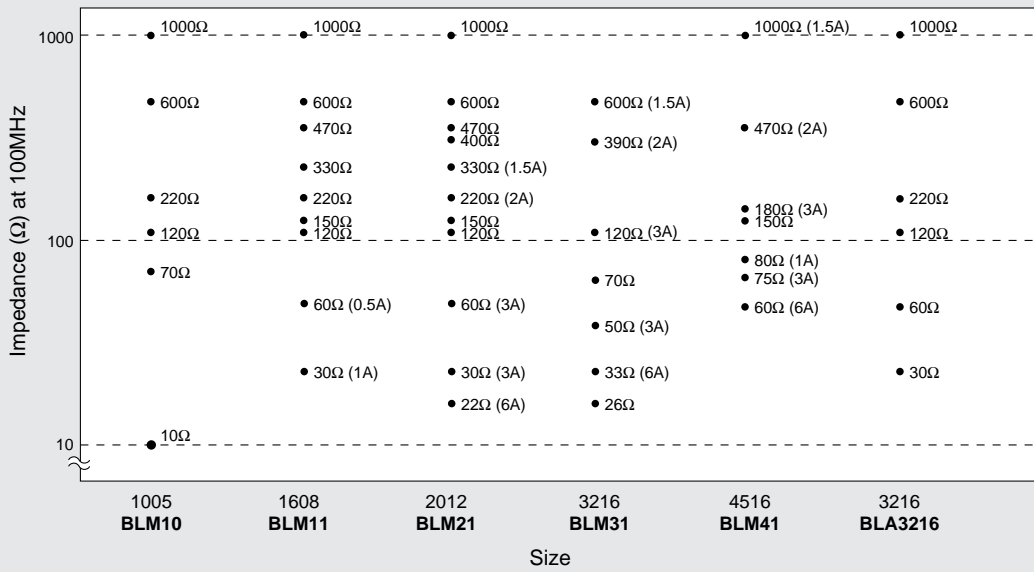

●BLM□□B series-For High Speed Signal

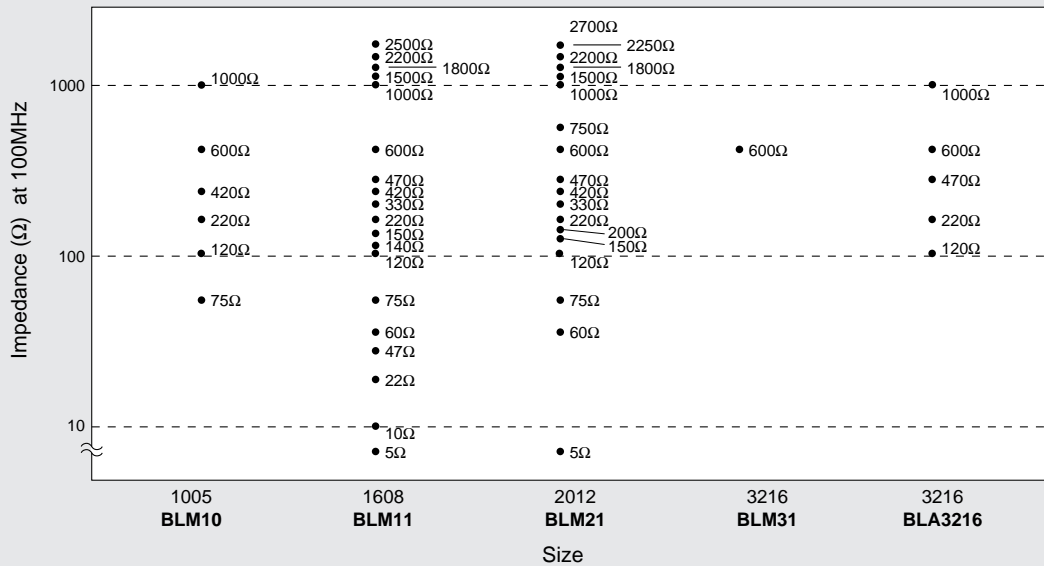

DIFFERENCE BETWEEN A SERIES, B SERIES AND R SERIES

The BLM□□B series has sharp impedance characteristics and it does not affect the signal frequency. The BLM□□R series has resistance especially growing in the lower frequency range. Therefore it can suppress the ringing effectively.

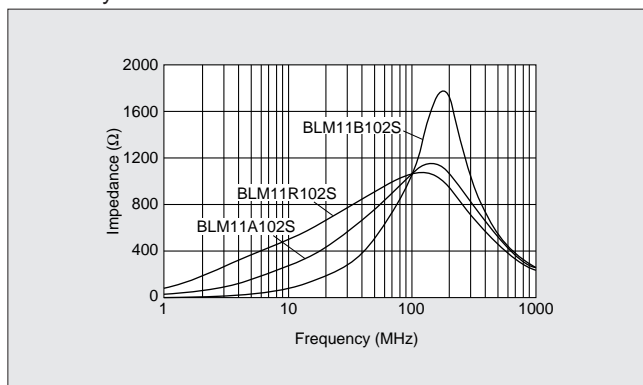

DERATING

When the BLM□□P series is for Large-current used in operating temperatures exceeding + 85°C, derating of current is necessary. Please apply the derating curve shown below according to the operating temperature.

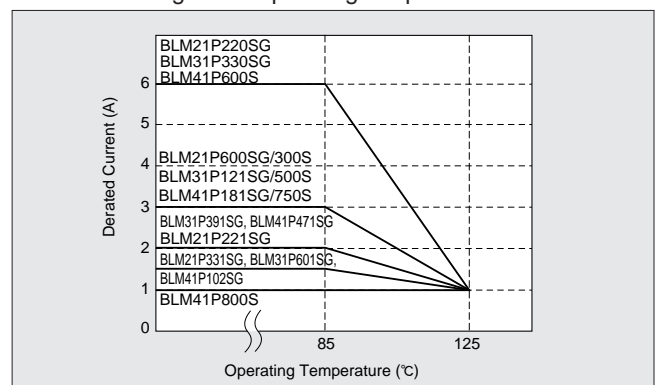

**WAVEFORM DISTORTION SUPPRESSING PERFORMANCE OF BLM□□R SERIES**

www.DataSheet4U.com

**Initial (no filter)**

● Signal waveform  
(100nsec/Div, 2V/Div)

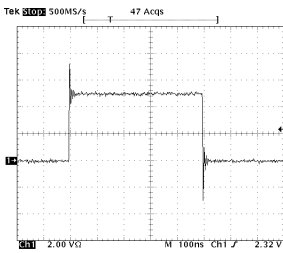

(10nsec/Div, 2V/Div)

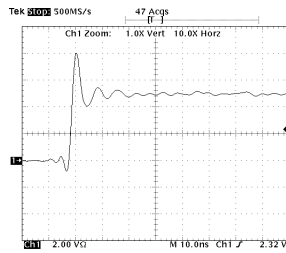

● Spectrum

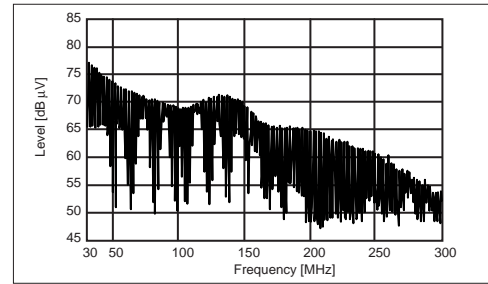

Ringing is caused on the signal waveform  
Such ringing contains several hundred MHz harmonic components and generates noise.

**Resistor (47Ω) is used**

● Signal waveform  
(100nsec/Div, 2V/Div)

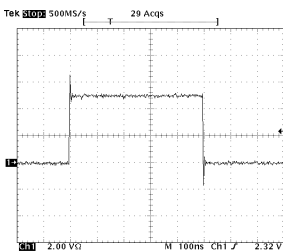

(10nsec/Div, 2V/Div)

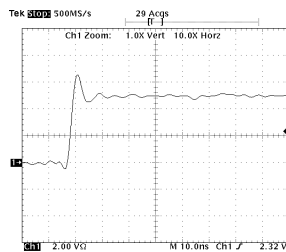

● Spectrum

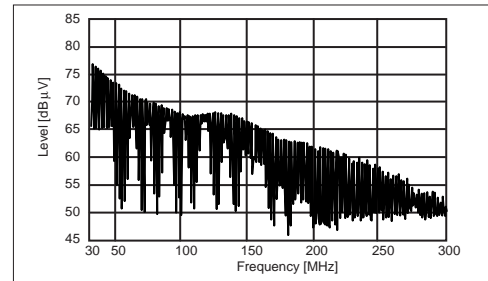

Comparing initial waveform, ringing is suppressed a little.  
However there still remains high level waveform distortion.

**BLM11R221SK (220Ω at 100MHz) is used**

● Signal waveform  
(100nsec/Div, 2V/Div)

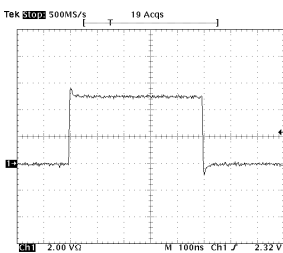

(10nsec/Div, 2V/Div)

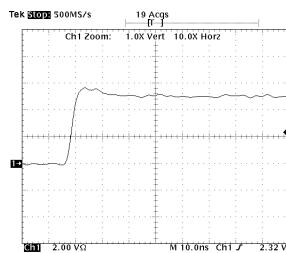

● Spectrum

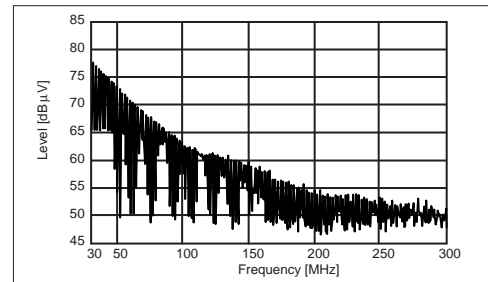

BLM11R has excellent performance for noise suppression and waveform distortion suppression.  
BLM11R suppresses drastically not only spectrum level in more than 100MHz range but waveform distortion.

**MEASURING CIRCUITS**

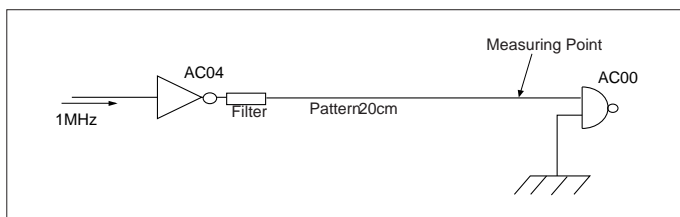



**BLM SERIES**

www.DataSheet4U.com  
Type

Type	Size (mm)	Part Number	Impedance (Ω) at 100MHz	Rated Current (mA)
BLM□□R Series -For Digital Interface	1.6×0.8	BLM11R121SK	120±25%	200
		BLM11R221SK	220±25%	
		BLM11R471SK	470±25%	
		BLM11R601SK	600±25%	
		BLM11R102SK	1000±25%	100
	2.0×1.25	BLM21R121SK	120±25%	200
		BLM21R221SK	220±25%	
		BLM21R471SK	470±25%	
		BLM21R601SK	600±25%	
		BLM21R102SK	1000±25%	
BLM□□A Series -For Standard	1.0×0.5	BLM10A100S	10 (Typ.)	500
		BLM10A700S	70 (Typ.)	200
		BLM10A121S	120 (Typ.)	100
		BLM10A221SG	220±25%	50
		BLM10A601SG	600±25%	
		BLM10A102SG	1000±25%	
	1.6×0.8	BLM11A121S	120±25%	200
		BLM11A151SG	150±25%	
		BLM11A221S	220±25%	
		BLM11A331SG	330±25%	
		BLM11A471SG	470±25%	
		BLM11A601S	600±25%	
	2.0×1.25	BLM11A102S	1000±25%	100
		BLM21A121F	120±25%	200
		BLM21A151SG	150±25%	
		BLM21A221SG	220±25%	
		BLM21A331SG	330±25%	
		BLM21A401S	400±25%	
		BLM21A471SG	470±25%	
		BLM21A601F	600±25%	
		BLM21A601S		
	BLM21A102F	1000±25%		
	BLM21A102S			
	3.2×1.6	BLM31A260S	26±25%	500
		BLM31A700S	70±25%	200
		BLM31A601S	600±25%	
	4.5×1.6	BLM41A800S	80±25%	500
		BLM41A151S	150±25%	200
BLM□□B Series -For High Speed Signal (Sharp impedance characteristic)	1.0×0.5	BLM10B750SB	75±25%	100
		BLM10B121SB	120±25%	50
		BLM10B221SB	220±25%	
		BLM10B421SD	420±25%	
		BLM10B601SD	600±25%	
		BLM10B102SD	1000±25%	50
	1.6×0.8	BLM11B050SA	5±25%	500
		BLM11B050SB		700
		BLM11B100SA	10±25%	500
		BLM11B100SB		
		BLM11B220SA	22±25%	500
		BLM11B220SB		
		BLM11B470SA	47±25%	300
		BLM11B470SB		500
		BLM11B600SB	60±25%	200
		BLM11B750S	75±25%	300
		BLM11B750SA		
		BLM11B121SA	120±25%	200
		BLM11B121SB		
		BLM11B121SD		



www.DataSheet4U.com

Type	Size (mm)	Part Number	Impedance (Ω) at 100MHz	Rated Current (mA)
BLM□□B Series -For High Speed Signal (Sharp impedance characteristic)	1.6×0.8	BLM11B141S	140±25%	200
		BLM11B151SB	150±25%	
		BLM11B151SD		
		BLM11B221SB	220±25%	
		BLM11B221SD		
		BLM11B331SB	330±25%	
		BLM11B331SD		
		BLM11B421S	420±25%	50
		BLM11B471SB	470±25%	
		BLM11B471SD		
		BLM11B601S	600±25%	200
		BLM11B102S	1000±25%	100
		BLM11B152SD	1500±25%	50
		BLM11B182S	1800±25%	
		BLM11B222SD	2200±25%	
BLM11B252SD	2500±25%			
BLM□□B Series -For High Frequency (Sharp impedance characteristic)	2.0×1.25	BLM21B050S	5±25%	500
		BLM21B600SB	60±25%	200
		BLM21B750S	75±25%	
		BLM21B121SB	120±25%	
		BLM21B121SD		
		BLM21B151SB	150±25%	
		BLM21B151SD		
		BLM21B201S	200±25%	
		BLM21B221SB	220±25%	
		BLM21B221SD		
		BLM21B331SB	330±25%	
		BLM21B331SD		
		BLM21B421S	420±25%	
		BLM21B471SB	470±25%	
		BLM21B471SD		
		BLM21B601S	600±25%	
		BLM21B751SD	750±25%	
		BLM21B102S	1000±25%	
		BLM21B152SD	1500±25%	
		BLM21B182SD	1800±25%	
		BLM21B222S	2250 (Typ)*	
BLM21B222SD	2200±25%			
BLM21B272S	2700±25%			
	3.2×1.6	BLM31B601FI	600±25%	300
BLM□□P Series -For Large Current	1.6×0.8	BLM11P300S	30 (Typ.)	1000
		BLM11P600S	60 (Typ.)	500
	2.0×1.25	BLM21P220SG	22 (Typ.)	6000
		BLM21P300S	30 (Typ.)	3000
		BLM21P600SG	60 (Typ.)	
		BLM21P221SG	220 (Typ.)	2000
		BLM21P331SG	330 (Typ.)	1500
	3.2×1.6	BLM31P330SG	33 (Typ.)	6000
		BLM31P500S	50 (Typ.)	3000
		BLM31P121SG	120 (Typ.)	
		BLM31P391SG	390 (Typ.)	2000
		BLM31P601SG	600 (Typ.)	1500
	4.5×1.6	BLM41P600S	60 (Typ.)	6000
		BLM41P750S	75 (Typ.)	3000
		BLM41P800S	80 (Typ.)	1000
		BLM41P181SG	180 (Typ.)	3000
		BLM41P471SG	470 (Typ.)	2000
BLM41P102SG		1000 (Typ.)	1500	

\*Impedance±25% guarantee type is also available. Please contact for further details.

www.DataSheet4U.com

Type		Size (mm)	Part Number	Impedance ( $\Omega$ ) at 100MHz	Rated Current (mA)
BLM□□H□ Series For GHz Range Noise Suppression	BLM□□HA Series -For Standard	1.6×0.8	BLM11HA471SG	470±25%	200
			BLM11HA601SG	600±25%	
			BLM11HA102SG	1000±25%	
	BLM□□HB Series -For High Speed Signal		BLM11HB471SD	470±25%	100
			BLM11HB601SD	600±25%	
			BLM11HB102SD	1000±25%	



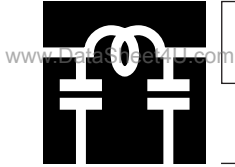

**CHIP EMIFIL®**

EMIFIL® is the trademark of Murata Manufacturing Co., Ltd.



Chip Ferrite Bead **BLM10** Series 1005 Size

■ SPECIFICATIONS

Part Number	Maximum Signal-Frequency (MHz)	Impedance (Ω) at 100MHz	Rated Current (mA)	DC Resistance (Ω max.)	Operating Temp. Range (°C)	
BLM10A100S	—	10 (Typ.)	500	0.05	-55 to +125	
BLM10A700S		70 (Typ.)		200		0.40
BLM10A121S		120 (Typ.)	100			0.50
BLM10A221SG		220±25%		50		0.70
BLM10A601SG		600±25%				1.10
BLM10A102SG		1000±25%	1.50			
BLM10B750SB		140	75±25%	100		0.80
BLM10B121SB	90	120±25%	50			1.10
BLM10B221SB	60	220±25%		1.40		
BLM10B421SD	20	420±25%		1.30		
BLM10B601SD		600±25%		1.50		
BLM10B102SD		15		1000±25%		1.30

■ DIMENSIONS

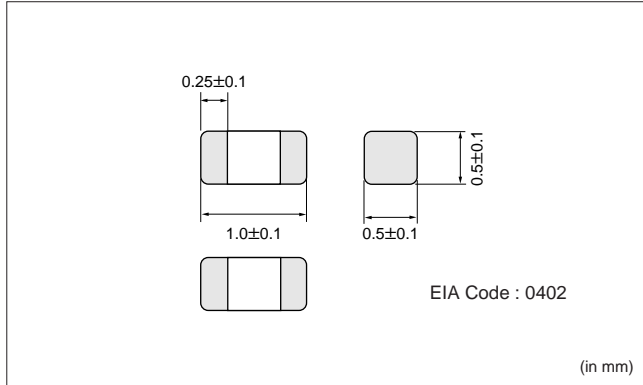

■ IMPEDANCE-FREQUENCY CHARACTERISTICS (TYPICAL)

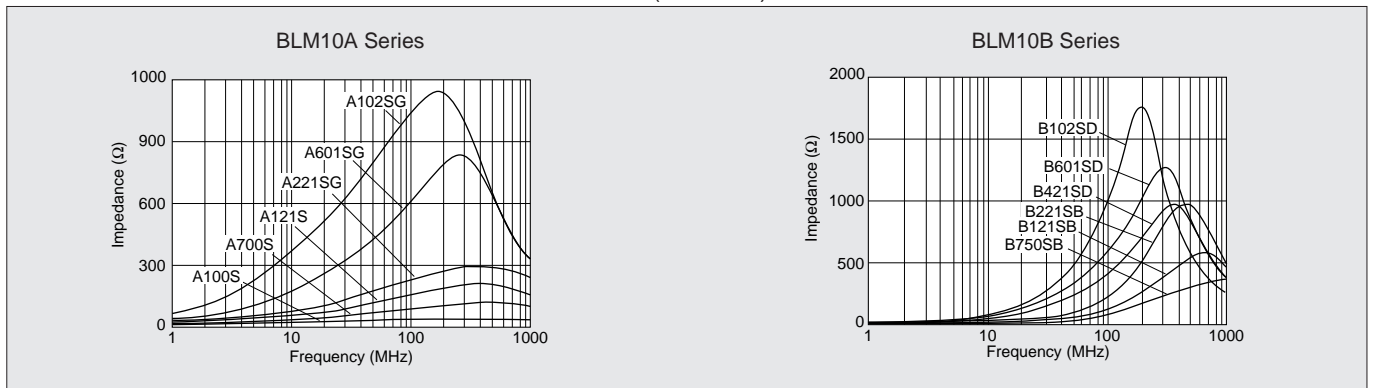

**■ IMPEDANCE-FREQUENCY CHARACTERISTICS (DETAILS)**

www.DataSheet4U.com

● **BLM10A Series**

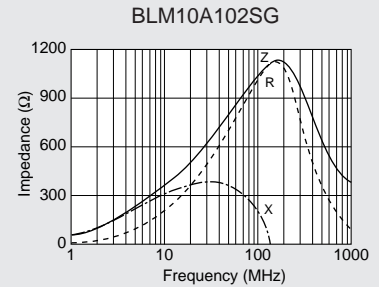
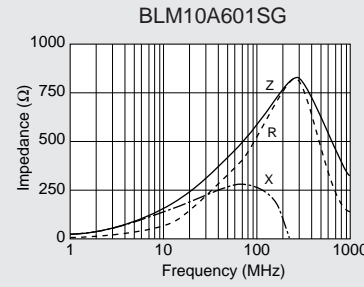
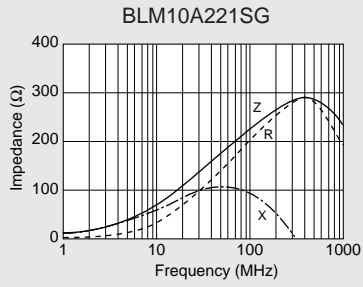
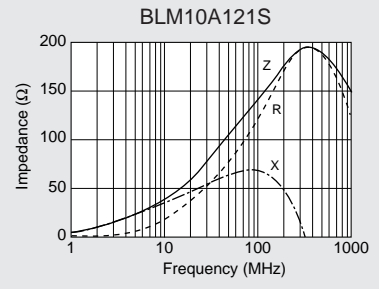
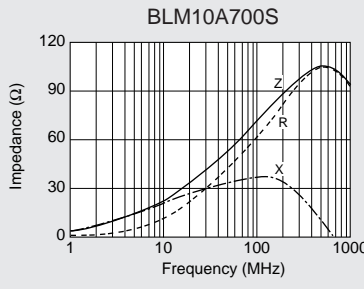
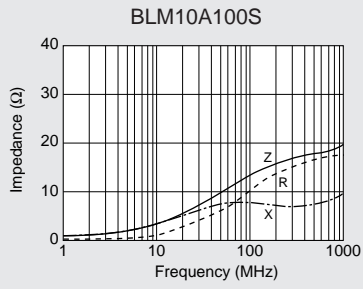

● **BLM10B Series**

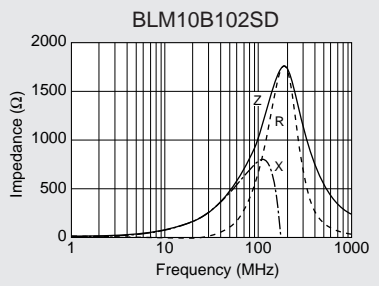
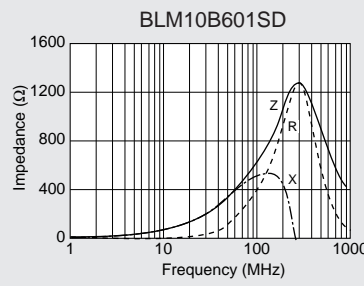
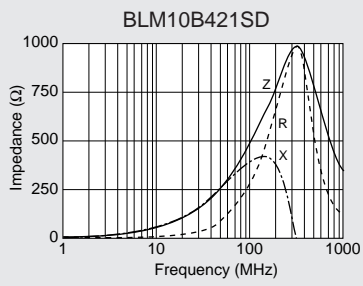
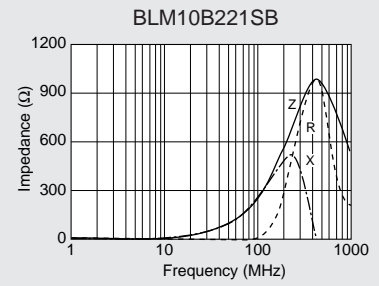
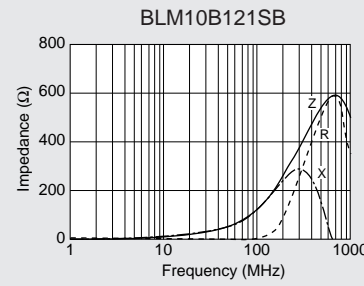
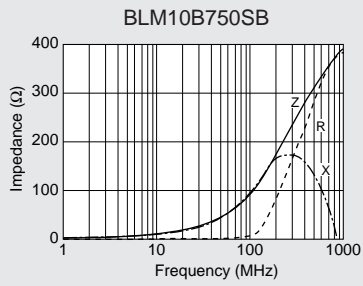

2

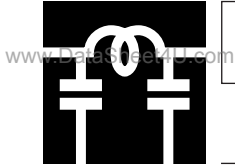

CHIP EMIFIL®

EMIFIL® is the trademark of Murata Manufacturing Co., Ltd.



Chip Ferrite Bead **BLM11** Series 1608 Size

■ SPECIFICATIONS

Part Number	Maximum Signal-Frequency (MHz)		Impedance (Ω) at 100MHz	Rated Current (mA)	DC Resistance (Ω max.)	Operating Temp. Range (°C)		
	*1	*2						
BLM11R121SK	-	-	120±25%	200	0.25	-55 to +125		
BLM11R221SK			220±25%		0.30			
BLM11R471SK			470±25%		0.50			
BLM11R601SK			600±25%		0.60			
BLM11R102SK			1000±25%	100	0.80			
BLM11A121S			-	-	120±25%		200	0.20
BLM11A151SG					150±25%			0.25
BLM11A221S					220±25%			0.30
BLM11A331SG					330±25%			0.45
BLM11A471SG					470±25%			0.50
BLM11A601S					600±25%			
BLM11A102S					1000±25%		100	0.70
BLM11B050SA	-	500			5±25%		500	0.20
BLM11B050SB					700		0.10	
BLM11B100SA		200			10±25%		500	0.25
BLM11B100SB			0.15					
BLM11B220SA			0.35					
BLM11B220SB		100	22±25%	300	0.25			
BLM11B470SA					0.55			
BLM11B470SB		50	47±25%	500	0.30			
BLM11B600SB				150	-		200	0.35
BLM11B750S		140	30	300				0.70
BLM11B750SA		-			20		200	0.90
BLM11B121SA		90	120±25%	0.50				
BLM11B121SB		70		0.40				
BLM11B141S		80		140±25%	0.55			
BLM11B151SB		50		150±25%	0.40			
BLM11B221SB		60		220±25%	0.65			
BLM11B221SD		40			0.45			
BLM11B331SB		50		330±25%	0.75			
BLM11B331SD	30	0.50						
BLM11B421S	20	420±25%		50	0.55			
BLM11B471SB	30				470±25%	1.00		
BLM11B471SD	20	600±25%		200	0.55			
BLM11B601S	15				1000±25%	100	0.65	
BLM11B102S	7	-	1500±25%	50	0.85			
BLM11B152SD			1800±25%		1.20			
BLM11B182S			2200±25%		1.50			
BLM11B222SD			2500±25%					
BLM11B252SD			5		30 (Typ.)	1000	0.05	
BLM11P300S	-	60 (Typ.)	500	0.10				
BLM11P600S	-	-	-	-	-			

\*1 has sharp impedance characteristic suitable for high speed lines. (At Maximum Signal Frequency insertion loss is 6dB in 50Ω impedance circuit.)  
 \*2 marked items are designed for ultra-high speed signal lines such as next generation memory interface. Since these impedance curve rise from several hundred MHz, these items can suppress noise unless the misoperation of circuits. (At Maximum Signal Frequency, impedance is 22Ω which is used as Dumping.)

**■ DIMENSIONS**

www.DataSheet4U.com

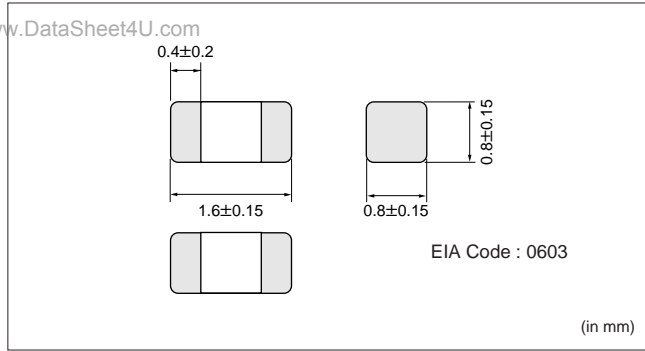

**■ IMPEDANCE-FREQUENCY CHARACTERISTICS (TYPICAL)**

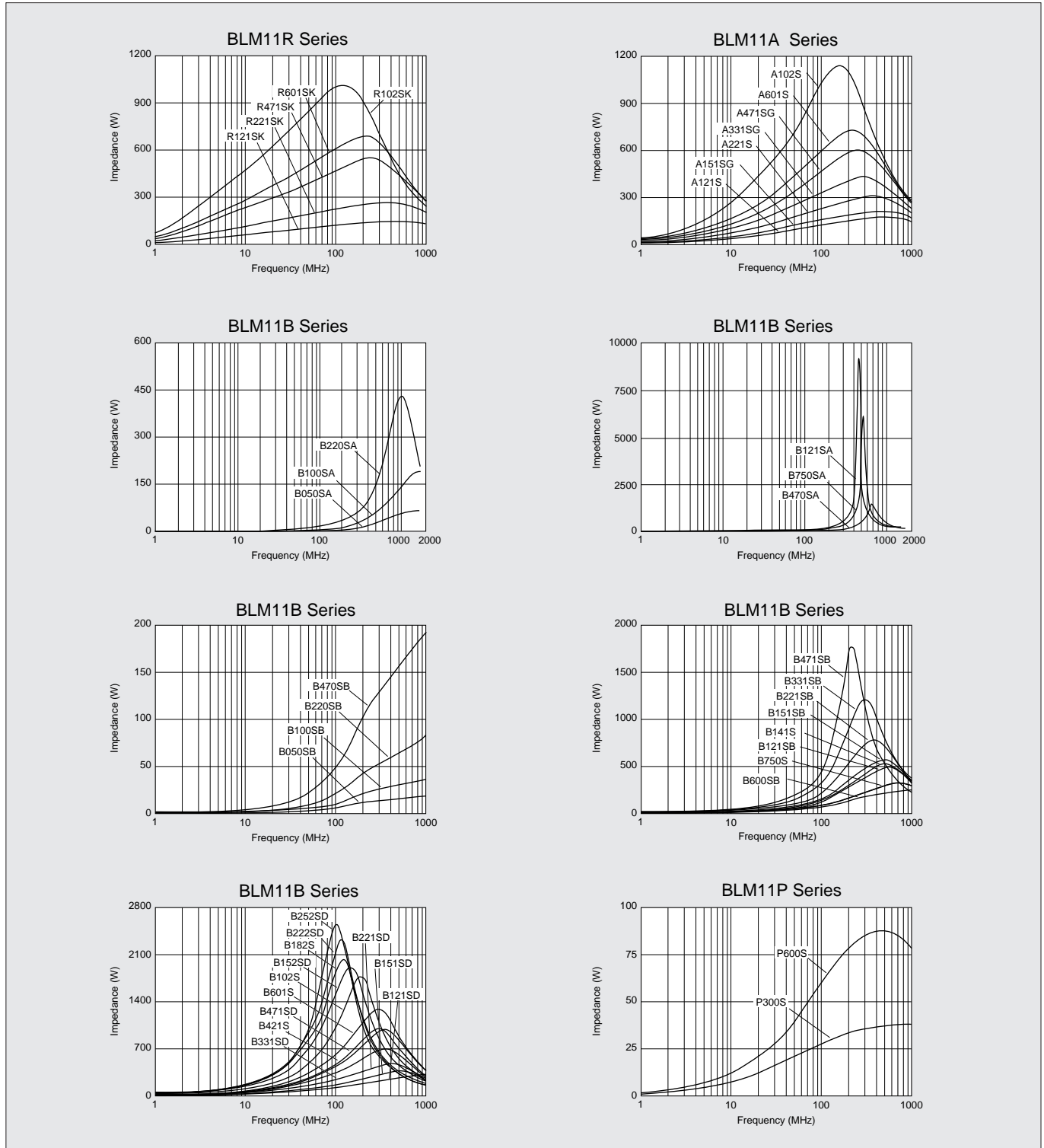

2

### ■IMPEDANCE-FREQUENCY CHARACTERISTICS (DETAILS)

www.DataSheet4U.com

#### ●BLM11R Series

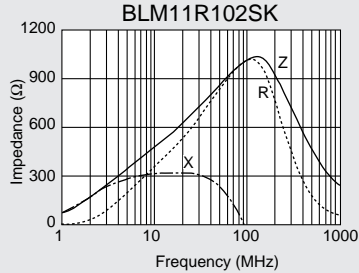
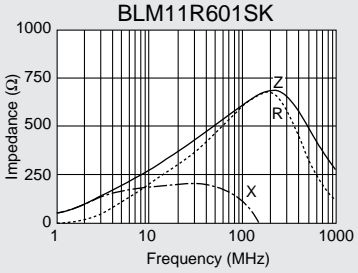
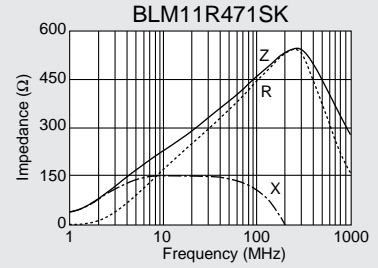
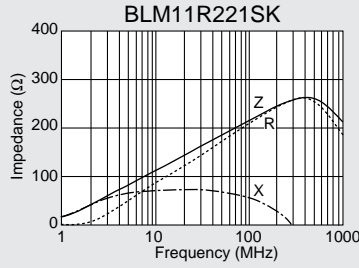
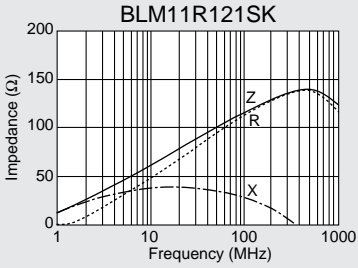

#### ●BLM11A Series

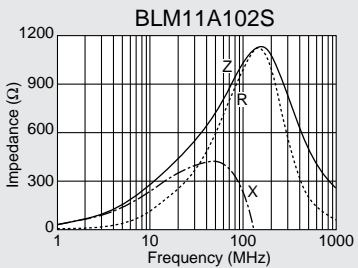
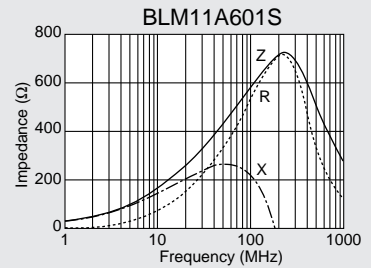
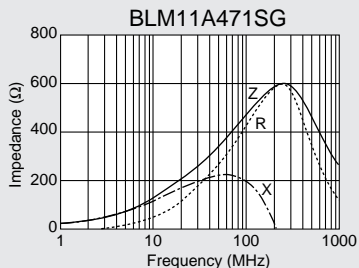
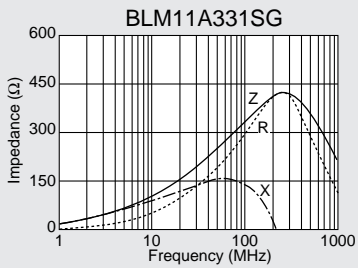
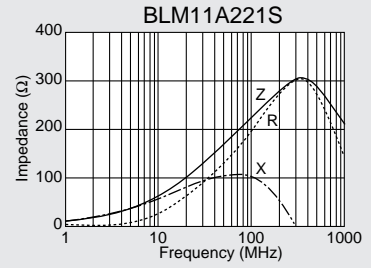
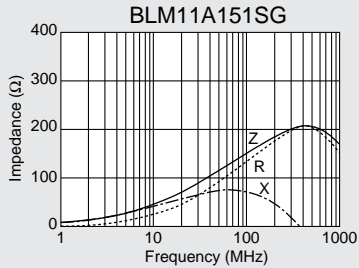
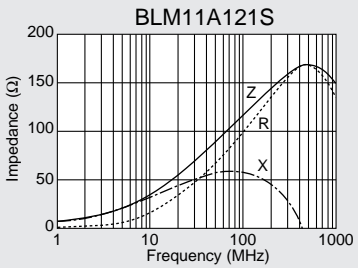

#### ●BLM11B Series

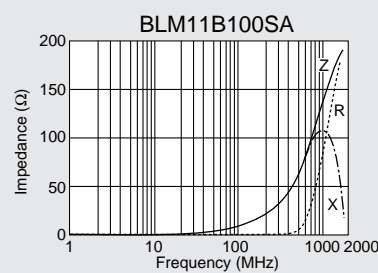
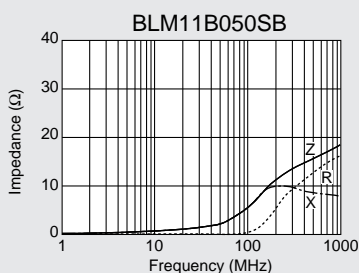
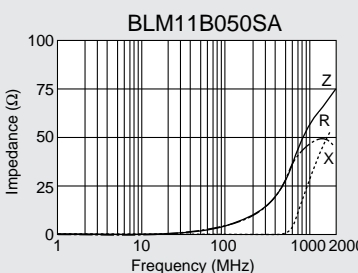



www.DataSheet4U.com

2

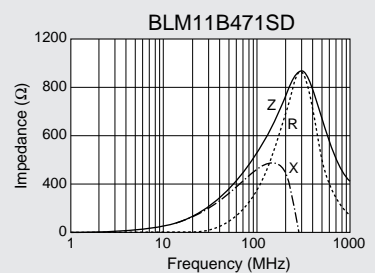
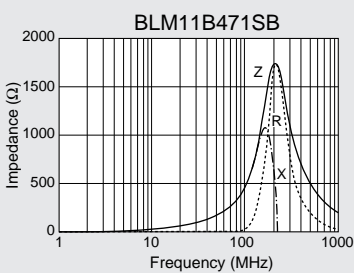
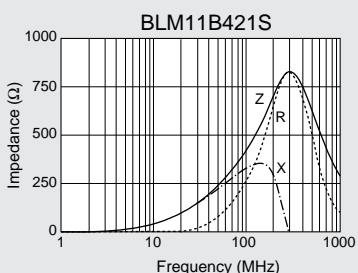
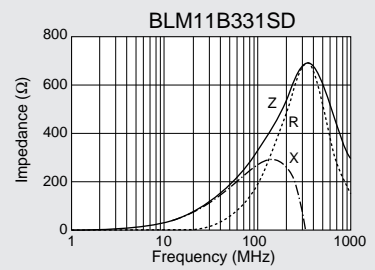
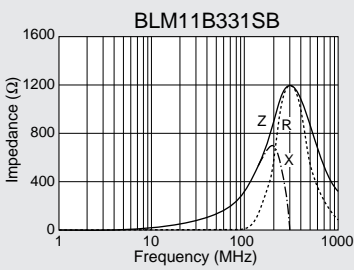
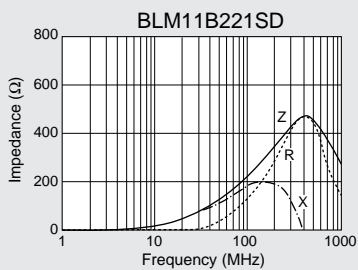
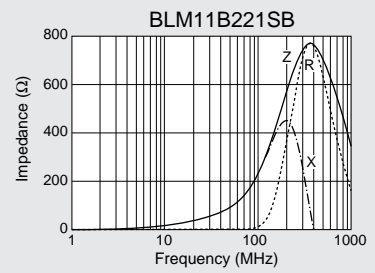
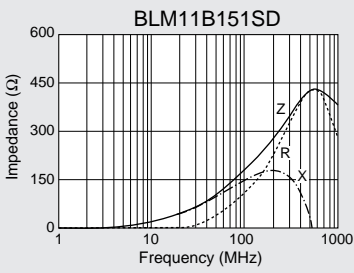
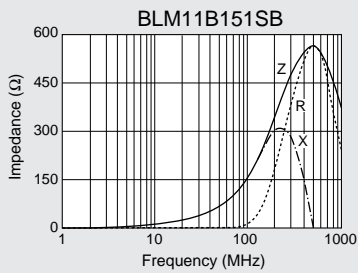
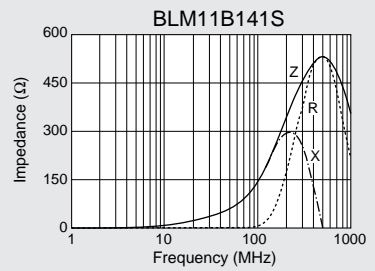
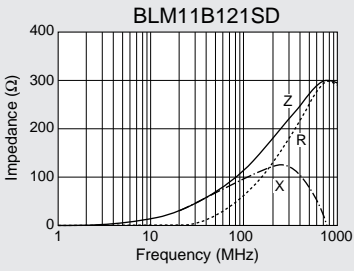
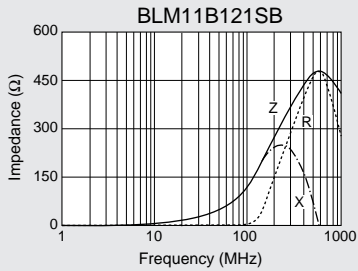
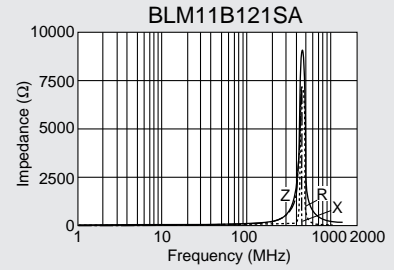
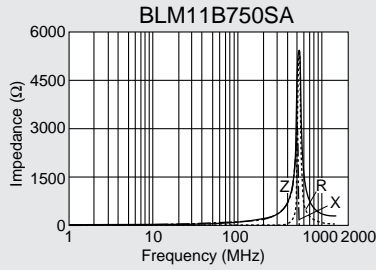
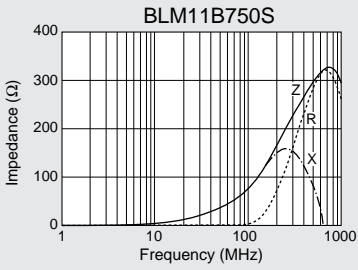
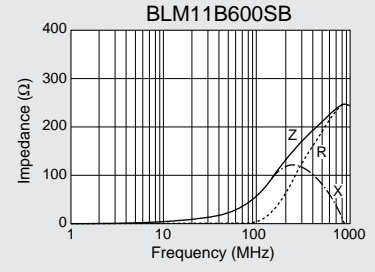
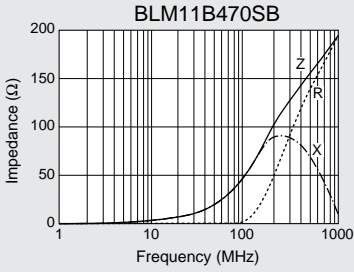
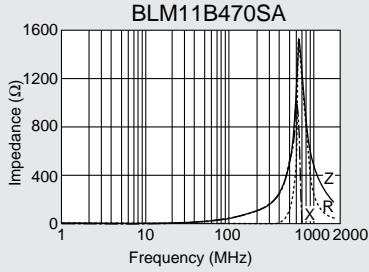
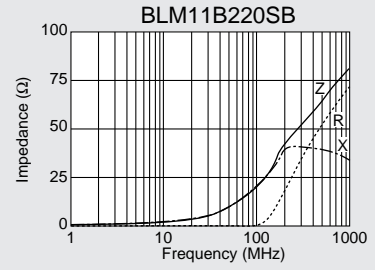
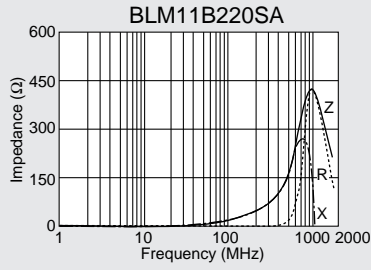
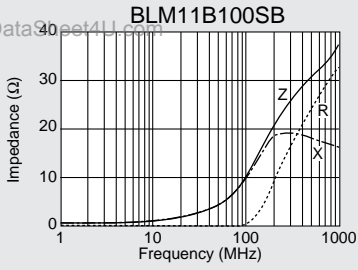

www.DataSheet4U.com

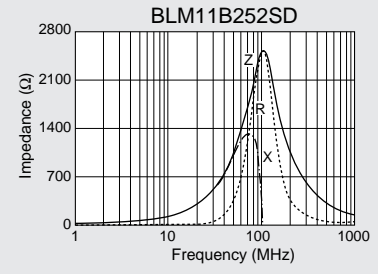
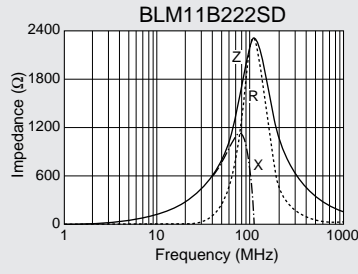
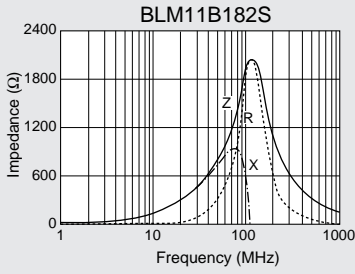
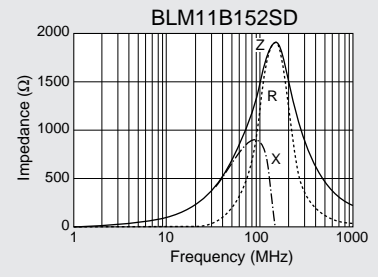
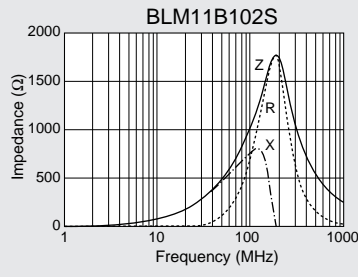
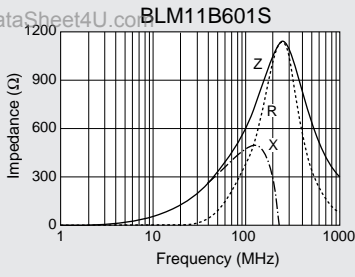

● BLM11P Series

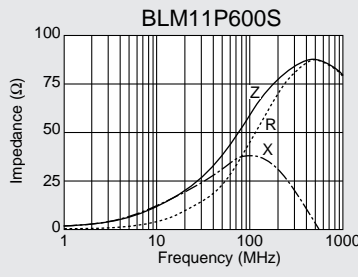
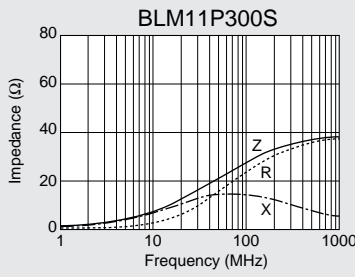

2

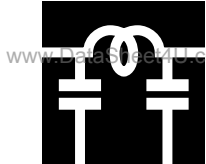
**CHIP EMIFIL®**

 EMIFIL® is the trademark of  
Murata Manufacturing Co., Ltd.



**Chip Ferrite Bead BLM21 Series 2012 Size**
**■ SPECIFICATIONS**

Part Number	Maximum Signal-Frequency (MHz)	Impedance (Ω) at 100MHz	Rated Current (mA)	DC Resistance (Ω max.)	Operating Temp. Range (°C)
BLM21R121SK	—	120±25%	200	0.15	-55 to +125*2
BLM21R221SK		220±25%		0.20	
BLM21R471SK		470±25%		0.25	
BLM21R601SK		600±25%		0.30	
BLM21R102SK		1000±25%		0.50	
BLM21A121F		120±25%	200	0.15	
BLM21A151SG		150±25%		0.20	
BLM21A221SG		220±25%		0.25	
BLM21A331SG		330±25%		0.85	
BLM21A401S		400±25%		0.25	
BLM21A471SG		470±25%		0.30	
BLM21A601F		600±25%		1.10	
BLM21A601S		600±25%		0.45	
BLM21A102F		1000±25%		0.45	
BLM21A102S		1000±25%		0.45	
BLM21B050S	—	5±25%*1	500	0.07	-55 to +85
BLM21B600SB	150	60±25%*1	—	0.20	
BLM21B750S	140	75±25%*1	200	0.25	-55 to +125
BLM21B121SB	190	120±25%*1			
BLM21B121SD	70	150±25%*1			
BLM21B151SB	80				
BLM21B151SD	50	200±25%*1			
BLM21B201S	70	220±25%*1			
BLM21B221SB	60	330±25%*1			
BLM21B221SD	40				
BLM21B331SB	50	420±25%*1			
BLM21B331SD	30	470±25%*1			
BLM21B421S	20				
BLM21B471SB	30	600±25%*1			
BLM21B471SD	20				
BLM21B601S	20	750±25%*1			
BLM21B751SD	15	1000±25%*1			
BLM21B102S		1500±25%*1			
BLM21B152SD	7	1800±25%*1			
BLM21B182SD		2250*1(Typ.)*3			
BLM21B222S	5	2200±25%*1			
BLM21B222SD		2700±25%*1			
BLM21B272S		2700±25%*1			
BLM21P220SG	—	22 (Typ.)	6000	0.01	
BLM21P300S		30 (Typ.)	3000	0.015	
BLM21P600SG		60 (Typ.)		0.025	
BLM21P221SG		220 (Typ.)	2000	0.050	
BLM21P331SG		330 (Typ.)	1500	0.09	

\*1 has sharp impedance characteristic suitable for high speed lines.

\*2 BLM21P series : Please derate the maximum current, as shown in previous page, for temperatures above +85°C.

\*3 Impedance ±25% guarantee type is also available. Please contact for further details.

**■ DIMENSIONS**

www.DataSheet4U.com

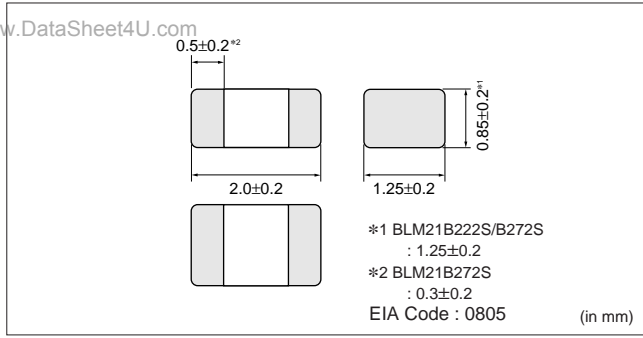

**■ IMPEDANCE-FREQUENCY CHARACTERISTICS (TYPICAL)**

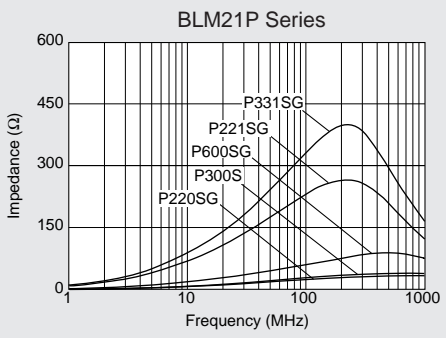
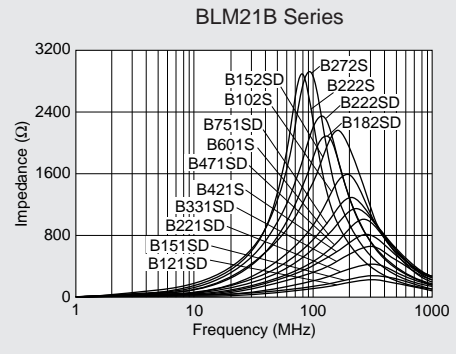
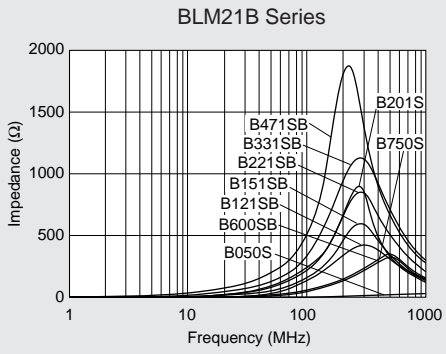
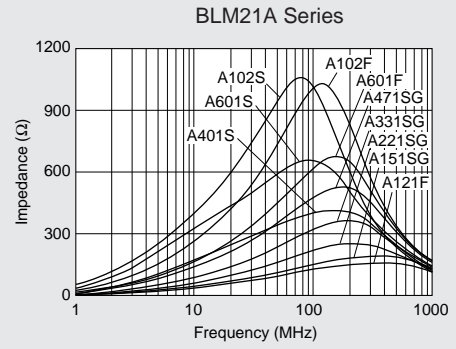
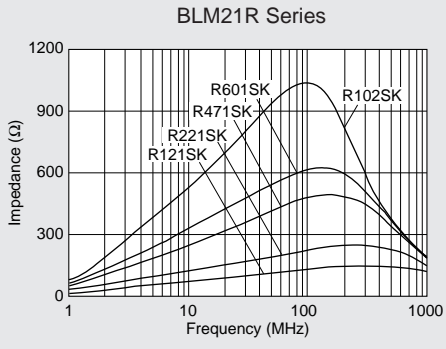

2

### ■IMPEDANCE-FREQUENCY CHARACTERISTICS (DETAILS)

www.DataSheet4U.com

#### ●BLM21R Series

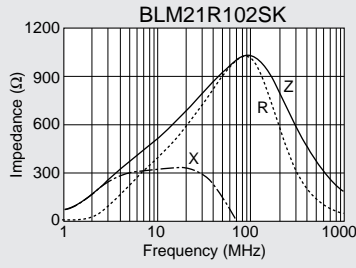
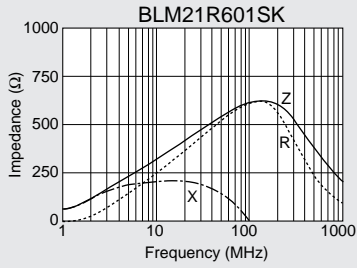
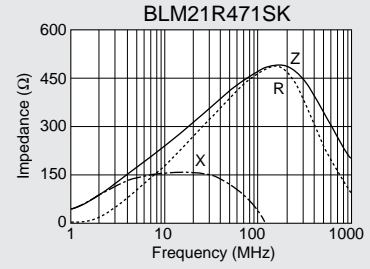
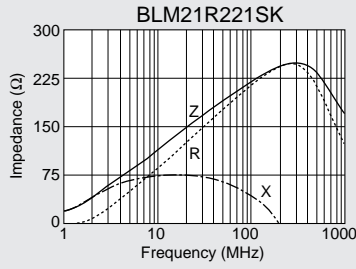
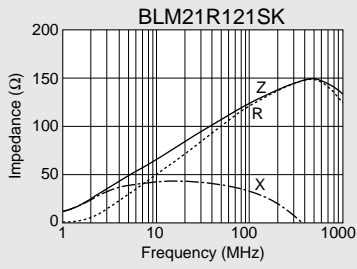

#### ●BLM21A Series

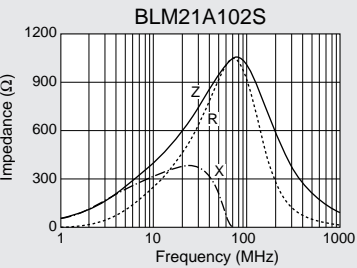
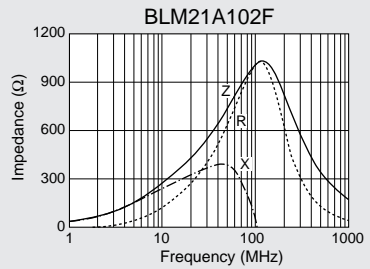
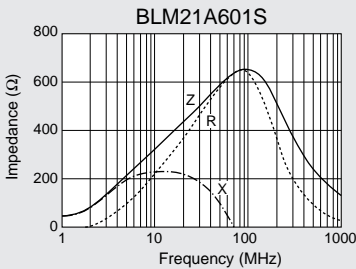
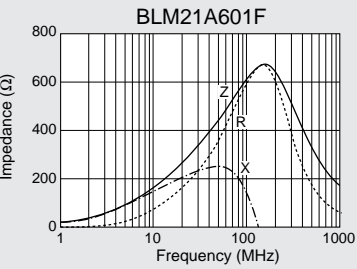
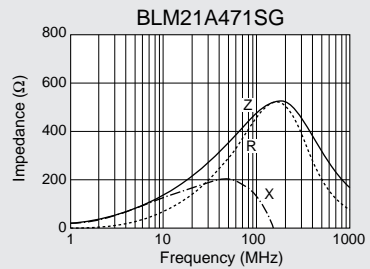
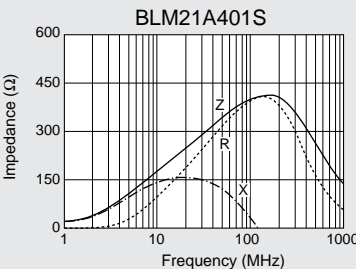
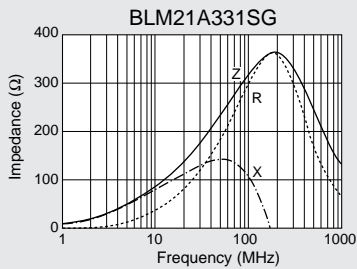
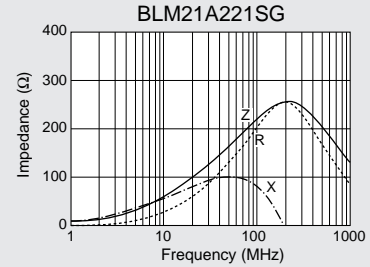
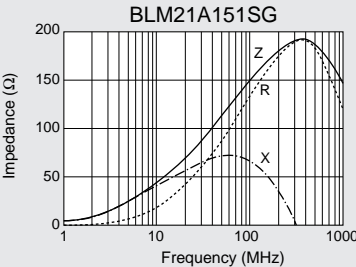
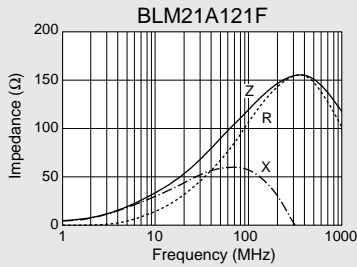

● BLM21B Series

www.DataSheet4U.com

2

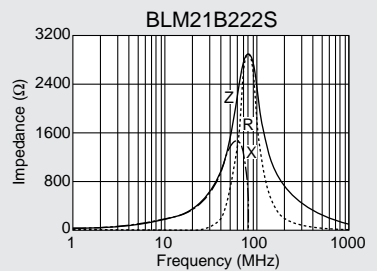
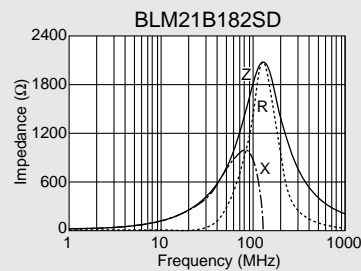
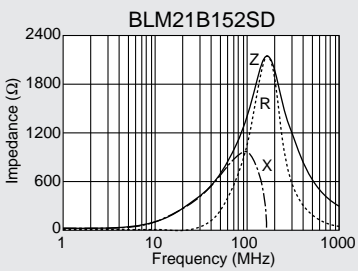
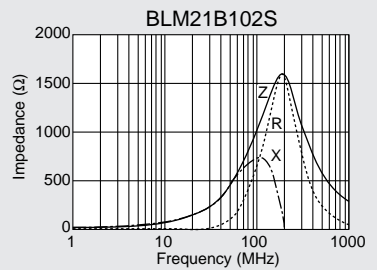
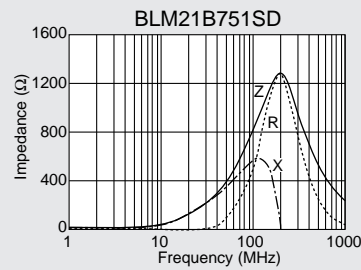
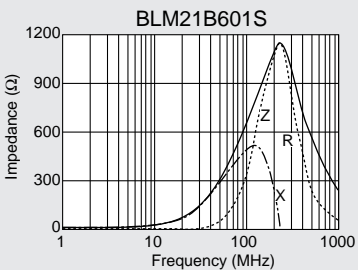
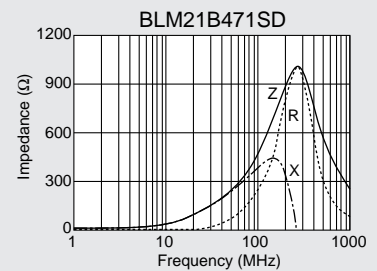
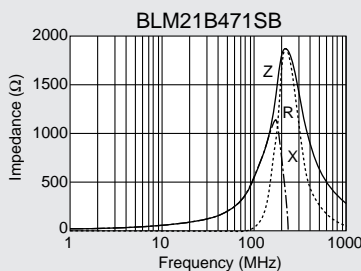
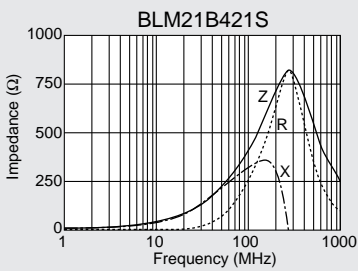
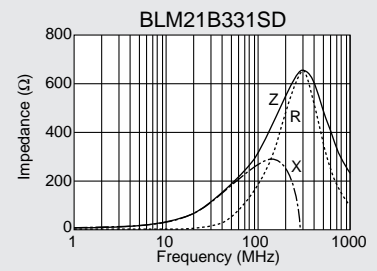
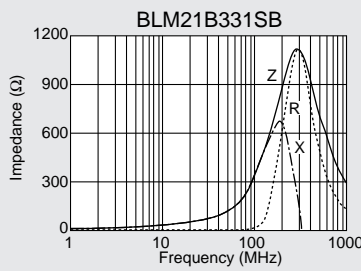
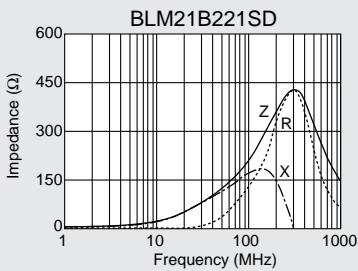
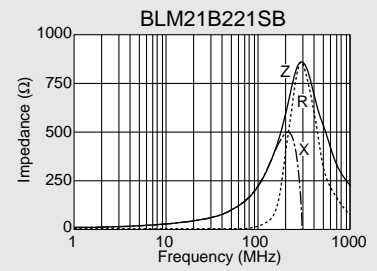
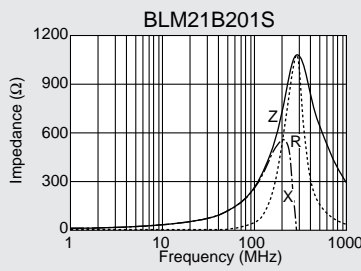
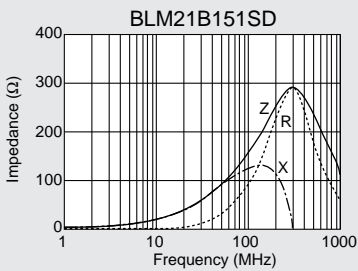
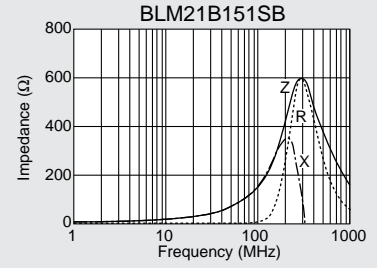
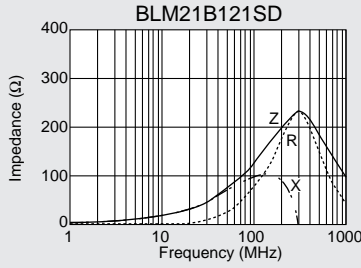
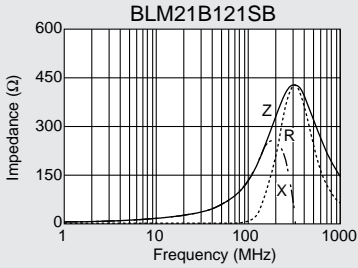
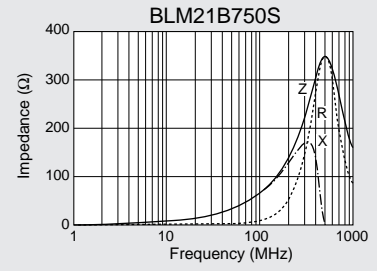
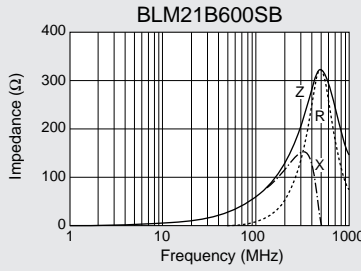
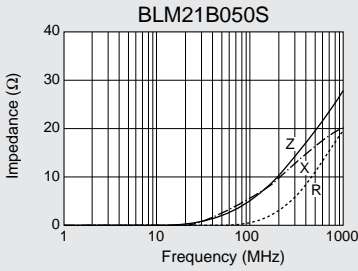

www.DataSheet4U.com

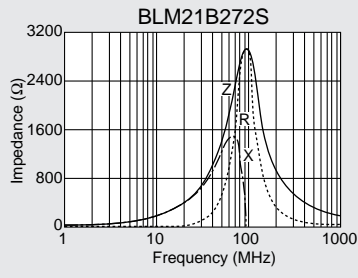
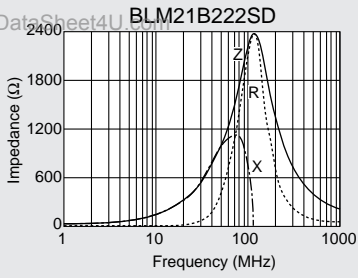

● BLM21P Series

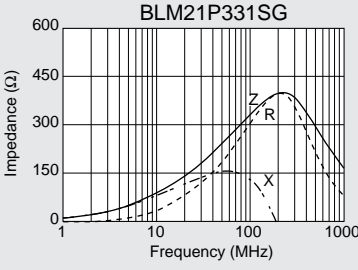
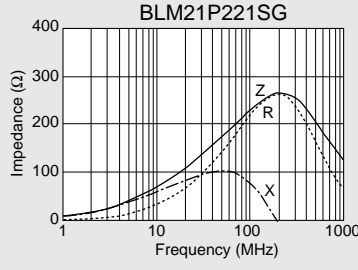
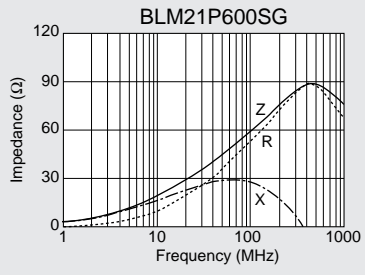
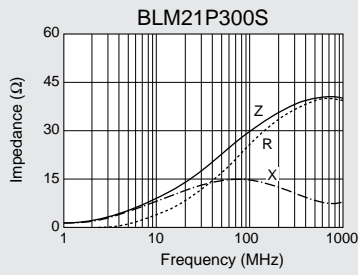
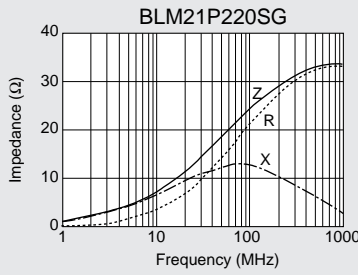

2

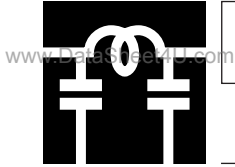

**CHIP EMIFIL®**

EMIFIL® is the trademark of Murata Manufacturing Co., Ltd.



Chip Ferrite Bead **BLM31** Series 3216 Size

■ SPECIFICATIONS

Part Number	Impedance (Ω) at 100MHz	Rated Current (mA)	DC Resistance (Ω max.)	Operating Temp. Range (°C)
BLM31A260S	26±25%	500	0.05	-55 to +125*2
BLM31A700S	70±25%	200	0.15	
BLM31A601S	600±25%		0.90	
BLM31B601FI*3	600±25%*1	300	0.35	
BLM31P330SG	33 (Typ.)	6000*2	0.01	
BLM31P500S	50 (Typ.)	3000*2	0.025	
BLM31P121SG	120 (Typ.)			
BLM31P391SG	390 (Typ.)	2000*2	0.05	
BLM31P601SG	600 (Typ.)	1500*2	0.90	

\*1 has sharp impedance characteristic suitable for high speed lines.  
 \*2 BLM31P series : Please derate the maximum current, as shown in previous page, for temperatures above +85°C.  
 \*3 BLM31B601FI is improved item from BLM31B601S.

■ DIMENSIONS

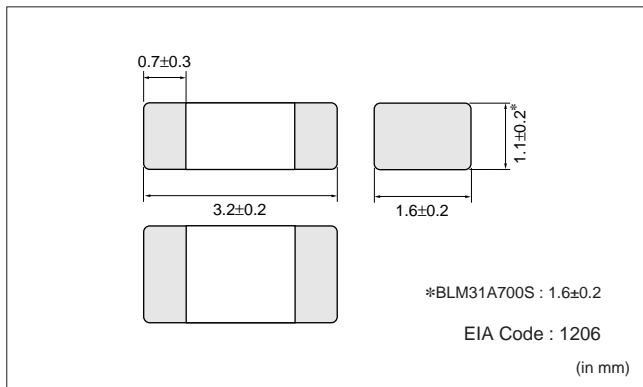

■ IMPEDANCE-FREQUENCY CHARACTERISTICS (TYPICAL)

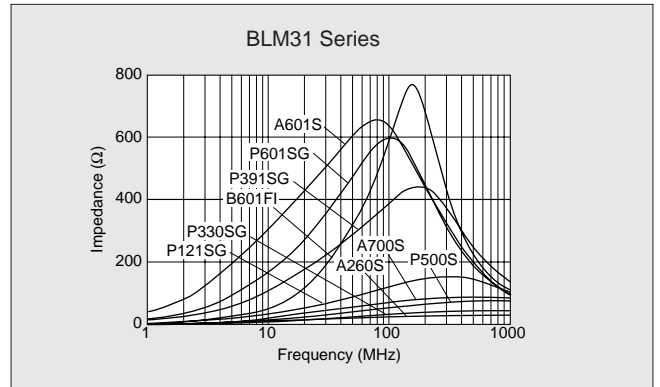



■ IMPEDANCE-FREQUENCY CHARACTERISTICS (DETAILS)

www.DataSheet4U.com

● BLM31A/B Series

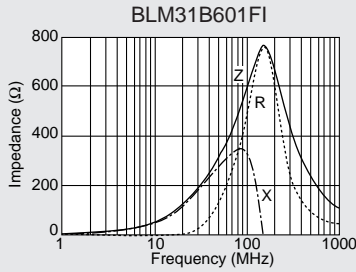
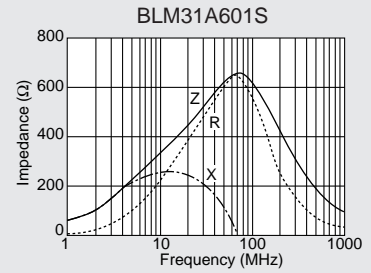
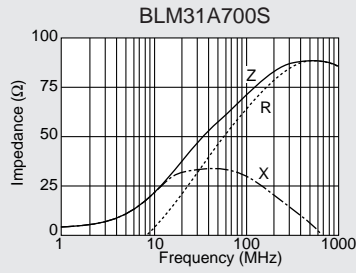
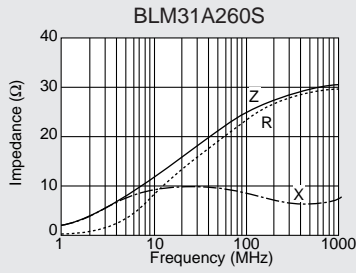

● BLM31P Series

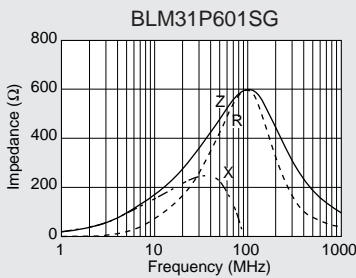
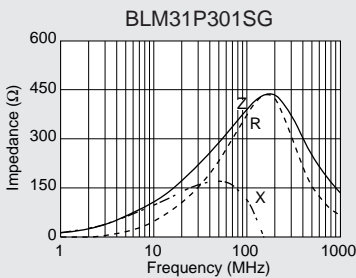
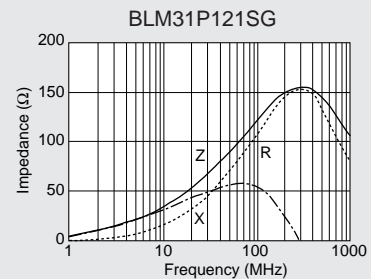
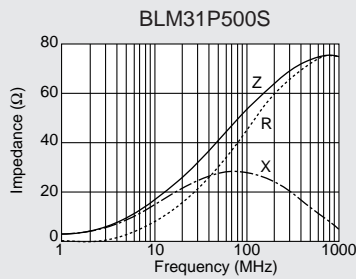
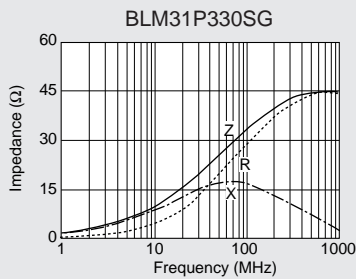

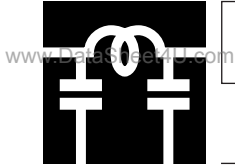

**CHIP EMIFIL®**

EMIFIL® is the trademark of Murata Manufacturing Co., Ltd.



Chip Ferrite Bead **BLM41** Series 4516 Size

■ SPECIFICATIONS

Part Number	Impedance (Ω) at 100MHz	Rated Current (mA)	DC Resistance (Ω max.)	Operating Temp. Range (°C)
BLM41A800S	80±25%	500	0.10	-55 to +125*
BLM41A151S	150±25%	200	0.50	
BLM41P600S	60 (Typ.)	6000*	0.01	
BLM41P750S	75 (Typ.)	3000*	0.025	
BLM41P800S	80 (Typ.)	1000*	0.10	
BLM41P181SG	180 (Typ.)	3000*	0.025	
BLM41P471SG	470 (Typ.)	2000*	0.05	
BLM41P102SG	1000 (Typ.)	1500*	0.09	

\*BLM41P series : Please derate the maximum current, as shown in previous page, for temperatures above +85°C.

■ DIMENSIONS

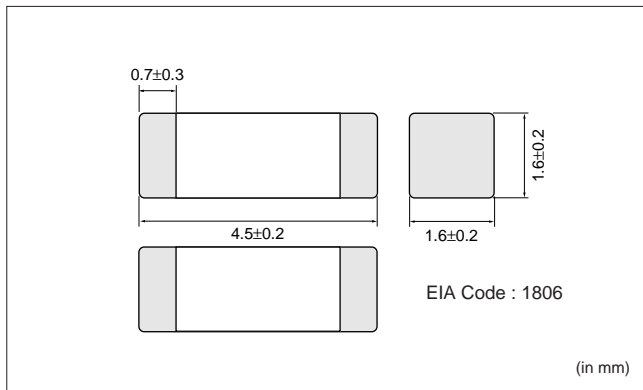

■ IMPEDANCE-FREQUENCY CHARACTERISTICS (TYPICAL)

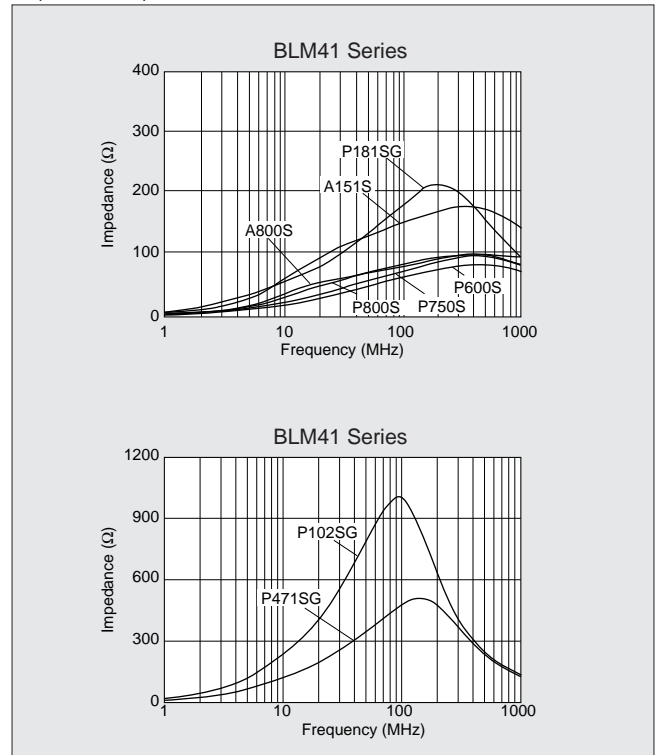

### ■ IMPEDANCE-FREQUENCY CHARACTERISTICS (DETAILS)

www.DataSheet4U.com

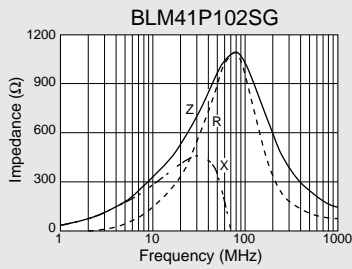
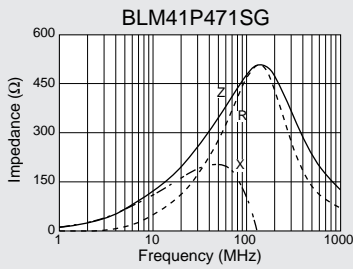
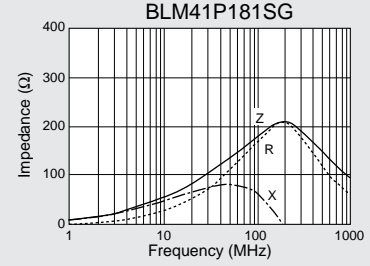
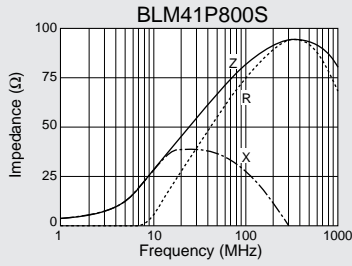
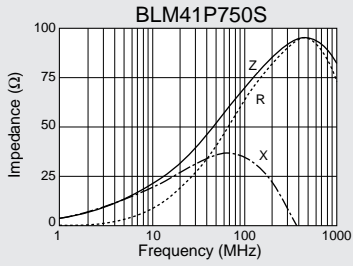
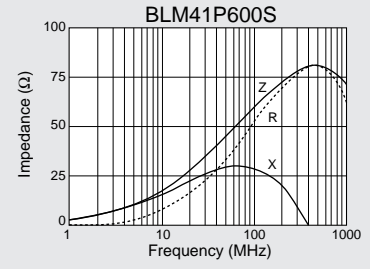
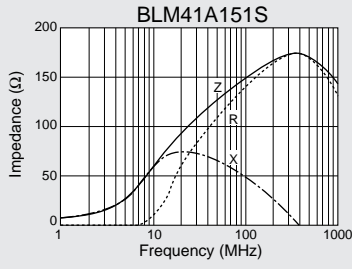
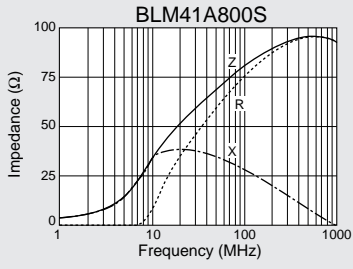



**■ IMPEDANCE-FREQUENCY CHARACTERISTICS (DETAILS)**

www.DataSheet4U.com

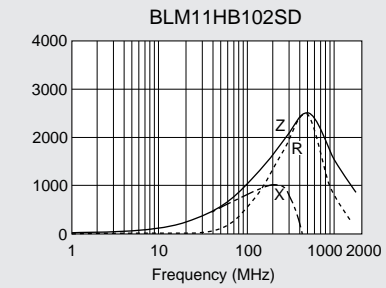
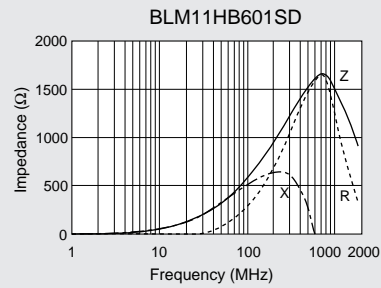
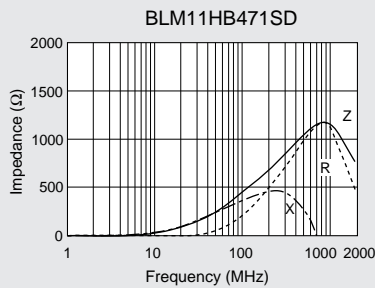
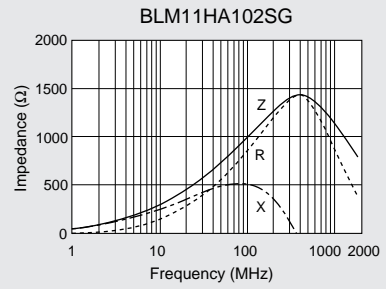
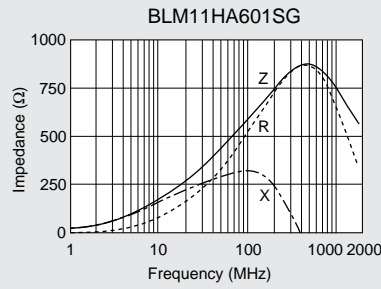
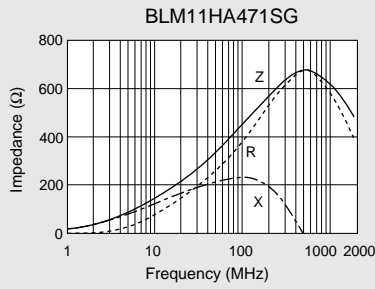

2

**■ NOISE SUPPRESSION IN UHF RANGE**

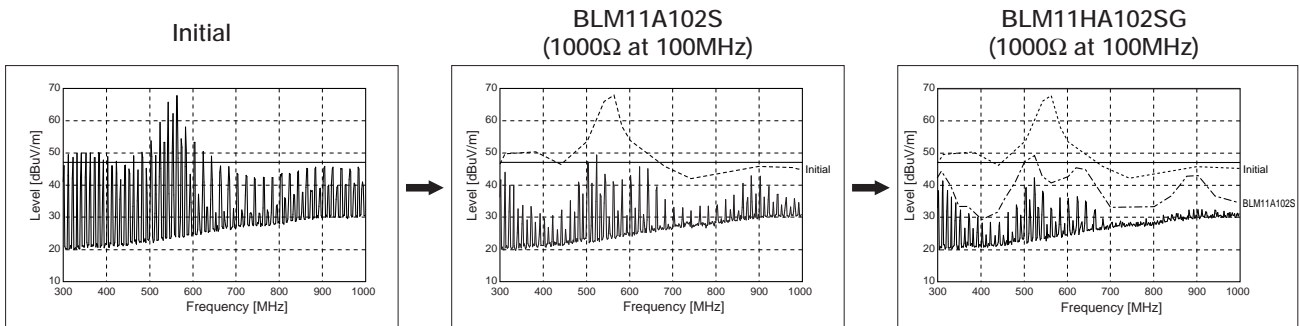

Current BLM are effective in suppressing noise in the range between 300MHz and 700MHz.

In addition to the effectiveness of current BLM, BLM11HA suppresses noise in the range beyond 700MHz.

**COMPARISON BETWEEN BLM11HA102SG AND BLM11A102S (CURRENT ITEM)**

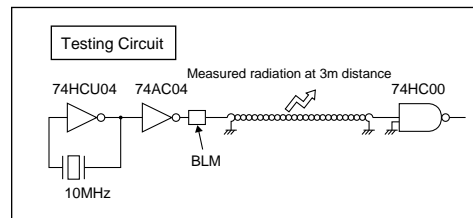
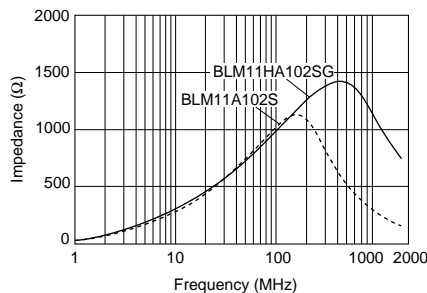

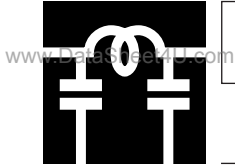

**CHIP EMIFIL®**

EMIFIL® is the trademark of Murata Manufacturing Co., Ltd.



Chip Ferrite Bead Array **BLA3216** Series

# 4 Components are Included in 3.2×1.6mm Chip

The miniaturize of electronic equipment requires high performance EMI filters which enables high density mounting. BLA3216 series consists of 4 circuit of ferrite bead inductor. BLA3216 is suitable for EMI suppression in smaller digital equipment.

### ■FEATURES

1. BLA3216 have 4 circuits in 3.2×1.6mm body with 0.8mm pitch.
2. Provides attenuation across a broad frequency range. Two types of impedance are available which meets general signal line and high speed signal line.
3. Original inner electrode structure enables extra low crosstalk.
4. The nickel barrier structure of the external electrodes provides excellent solder heat resistance. Both flow and reflow soldering methods can be employed.

### ■APPLICATIONS

- Notebook size PC, PDA and other compact size digital equipment

### ■PART NUMBERING

(Please specify the part number when ordering.)

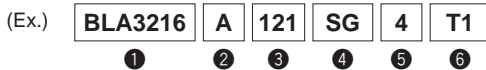

- ① Type
- ② Characteristics A : General B : High Speed
- ③ Typical Impedance at 100MHz 121 : 120Ω
- ④ Material Code
- ⑤ Number of Line
- ⑥ Packaging Code PT1 : Taped  
PB : Bulk package

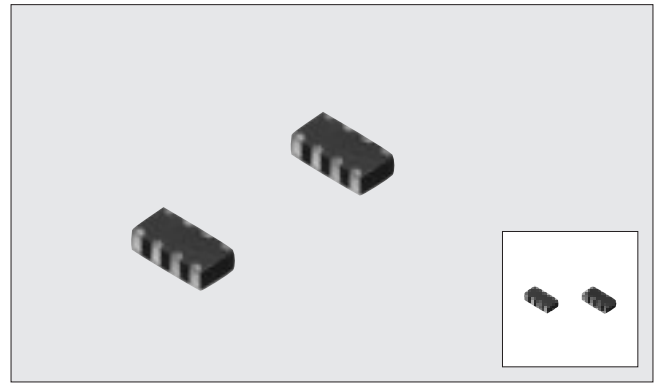

### ■DIMENSIONS

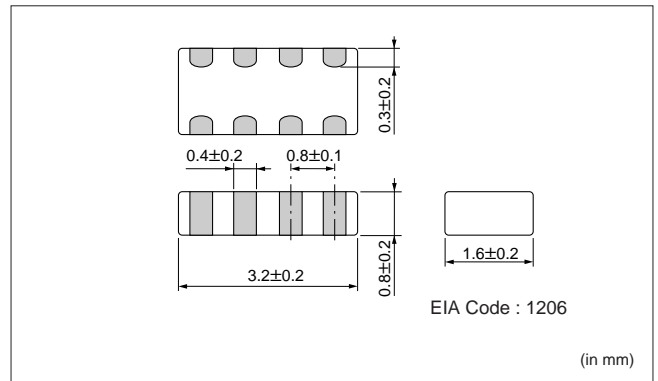

### ■EQUIVALENT CIRCUIT DIAGRAM

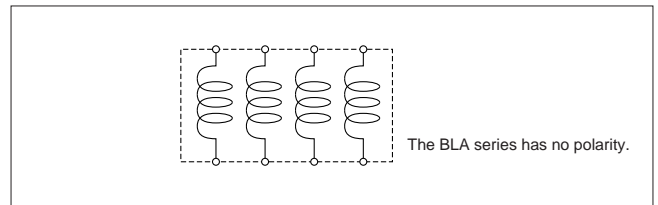

### ■SPECIFICATIONS

Part Number	Impedance (Ω) at 100MHz	Rated Current (mA)	DC Resistance (Ω max.)	IR Between Element (5Vdc)	Operating Temp. Range (°C)
BLA3216A300SG4	30±25%	200	0.10	100MΩ min.	-55 to +125
BLA3216A600SG4	60±25%		0.15		
BLA3216A121SG4	120±25%	150	0.20		
BLA3216A221SG4	220±25%		0.25		
BLA3216A601SG4	600±25%	100	0.35		
BLA3216A102SG4	1000±25%	50	0.45		
BLA3216B121SD4	120±25%	150	0.30		
BLA3216B221SD4	220±25%		0.35		
BLA3216B471SD4	470±25%	100	0.40		
BLA3216B601SD4	600±25%		0.45		
BLA3216B102SD4	1000±25%	50	0.55		

### ■IMPEDANCE-FREQUENCY CHARACTERISTICS (TYPICAL)

www.DataSheet4U.com

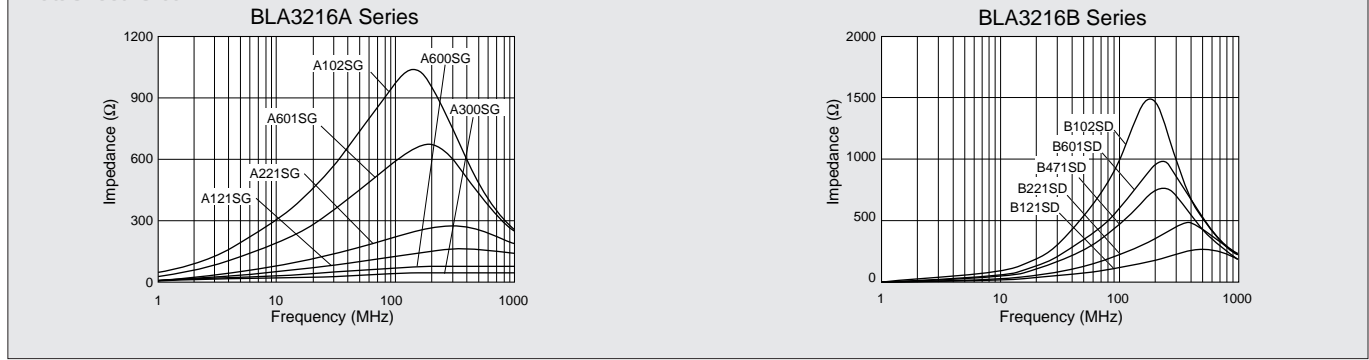

### ■IMPEDANCE-FREQUENCY CHARACTERISTICS (DETAILS)

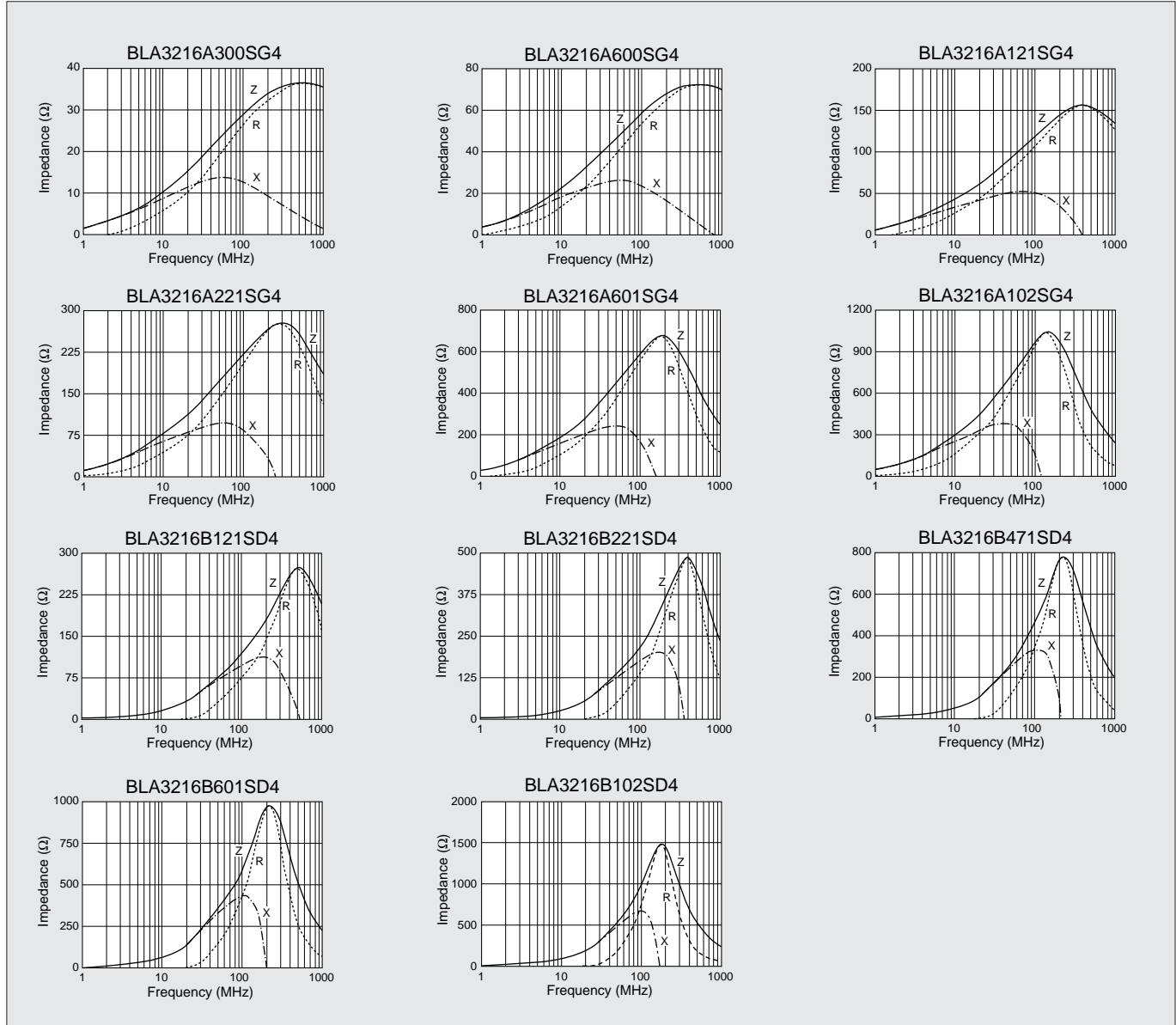

2

**■CHIP INDUCTOR FOR CHOKE USE**

There are chip inductors for choke use which are effective to suppress power line noise. Please find most suitable product in wide chip inductor for choke variation.

LQH3C

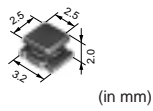

Part Number	Inductance (μH)	DC Resistance (Ω±30%)	Self-resonant Frequency (MHz min.)	Allowable Current (mA)
LQH3C○○○□34	1.0–560	0.09–22.0	5.0–96	60–800
LQH3C○○○□24	0.15–10	0.028–0.30	26–400	450–1450

● Impedance-Frequency Characteristics (Typical)

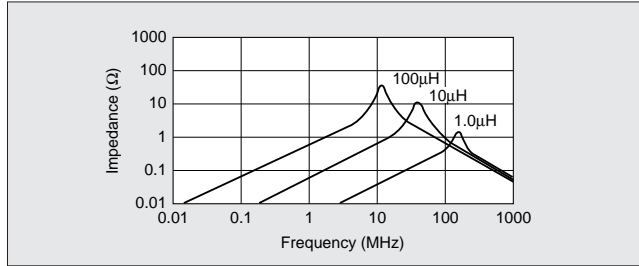

LQG21F

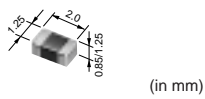

Part Number	Inductance (μH)	DC Resistance (Ω±30%)	Self-resonant Frequency (MHz min.)	Allowable Current (mA)
LQG21F○○○□00	1.0–47	0.20–0.60	7.5–105	7–220

● Impedance-Frequency Characteristics (Typical)

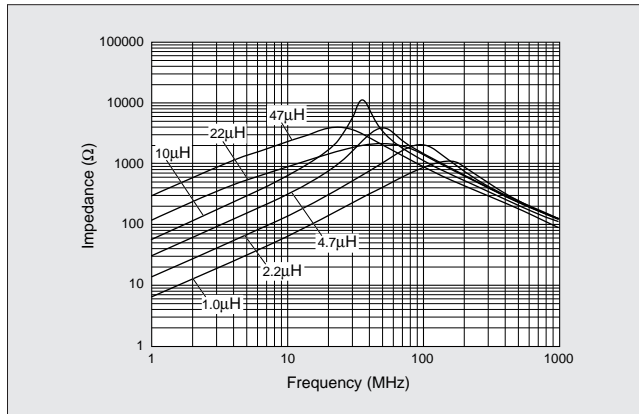



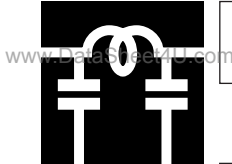

**CHIP EMIFIL®**

EMIFIL® is the trademark of Murata Manufacturing Co., Ltd.



**Chip Solid EMIFIL® NFM2012R/40R/3212R/41R/4516R Series**

The chip solid EMIFIL® NFM2012R\*/40R/3212R\*/41R/4516R\* series is a chip type 3-terminal EMI suppression filter. It can reduce residual inductance to an extremely low level making it excellent for noise suppression at high frequencies.

An electrostatic capacitance range of 22pF to 22000pF enables suppression of noise at specific frequencies. (The array type NFA series is also available.)

\*Using base metal to the electrode.

**FEATURES**

1. Small and low profile of 2.0mmX1.25mmX0.5mm (NFM2012R) enables high density mounting.
2. The 3 terminal structure enables high performance in high frequency range.
3. Use original electrode structure which realize excellent solderability.

**APPLICATIONS**

- PCs and peripherals which emit high amount of noise
- Compact size equipment such as PDA, PC card and mobile telecommunication equipments
- Severe EMI suppression and high impedance circuits such as digital circuits

**PART NUMBERING**

(Please specify the part number when ordering.)



- ① Type
- ② Class No.
- ③ Circuit Composition
- ④ Characteristics
- ⑤ Other Characteristics (NFM2012R/3212R/4516R)
- ⑥ Packaging Code    T1 : Taped  
                              B1 : Bulk package

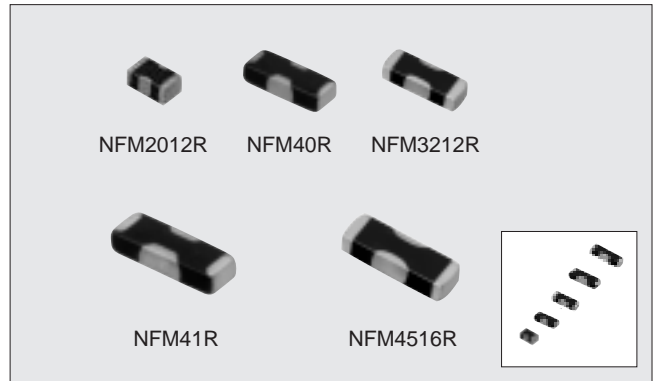

**EQUIVALENT CIRCUIT DIAGRAM**

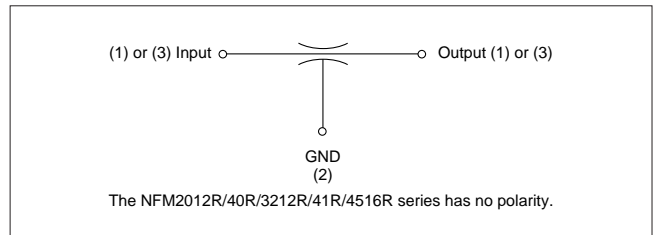

■ DIMENSIONS

www.DataSheet4U.com

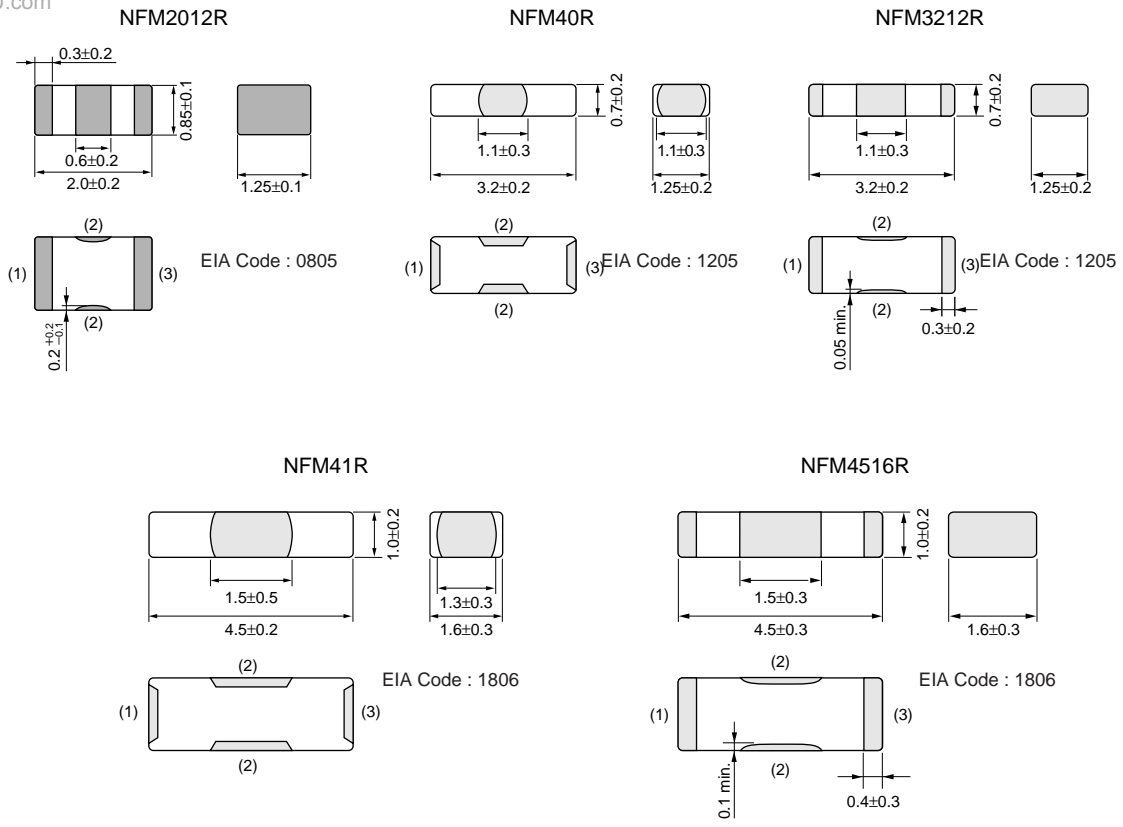

(in mm)

■ SPECIFICATIONS

NFM2012R Series

Part Number	Capacitance	Rated Voltage	Rated Current	Insulation Resistance	DC Resistance	Operating Temp. Range (°C)
NFM2012R03C220R	22pF±20%	50Vdc	300mAdc	1000MΩ min.	0.3Ω max.	-55 to +125
NFM2012R03C470R	47pF±20%					
NFM2012R03C101R	100pF±20%					
NFM2012R13C221R	220pF±20%					
NFM2012R13C471R	470pF±20%					
NFM2012R13C102R	1000pF±20%					
NFM2012R13C222R	2200pF±20%					
NFM2012R13C223R	22000pF±20%		1Adc		0.03Ω max.	

NFM40R Series

Part Number	Capacitance	Rated Voltage	Rated Current	Insulation Resistance	DC Resistance	Operating Temp. Range (°C)
NFM40R02C220	22pF±50%	25Vdc	300mAdc	1000MΩ min.	0.6Ω max.	-55 to +125
NFM40R02C470	47pF±50%					
NFM40R02C101	100pF±50%					

NFM3212R Series

Part Number	Capacitance	Rated Voltage	Rated Current	Insulation Resistance	DC Resistance	Operating Temp. Range (°C)
NFM3212R13C221R	220pF±50%	50Vdc	300mAdc	1000MΩ min.	0.3Ω max.	-55 to +125
NFM3212R13C471R	470pF±50%					
NFM3212R13C102R	1000pF±50%					
NFM3212R13C222R	2200pF±50%					
NFM3212R13C223R	22000pF±50%					

**NFM41R Series**

Part Number	Capacitance	Rated Voltage	Rated Current	Insulation Resistance	DC Resistance	Operating Temp. Range (°C)
NFM41R02C220	22pF±50%	100Vdc	300mAdc	10000MΩ min.	0.3Ω max.	-55 to +125
NFM41R02C470	47pF±50%					
NFM41R02C101	100pF±50%					
NFM41R02C221	220pF±50%					

**NFM4516R Series**

Part Number	Capacitance	Rated Voltage	Rated Current	Insulation Resistance	DC Resistance	Operating Temp. Range (°C)
NFM4516R13C471R	470pF±50%	100Vdc	300mAdc	10000MΩ min.	0.3Ω max.	-55 to +125
NFM4516R13C102R	1000pF±50%					
NFM4516R13C222R	2200pF±50%					
NFM4516R13C223R	22000pF±50%					

**■ INSERTION LOSS CHARACTERISTIC (TYPICAL)**

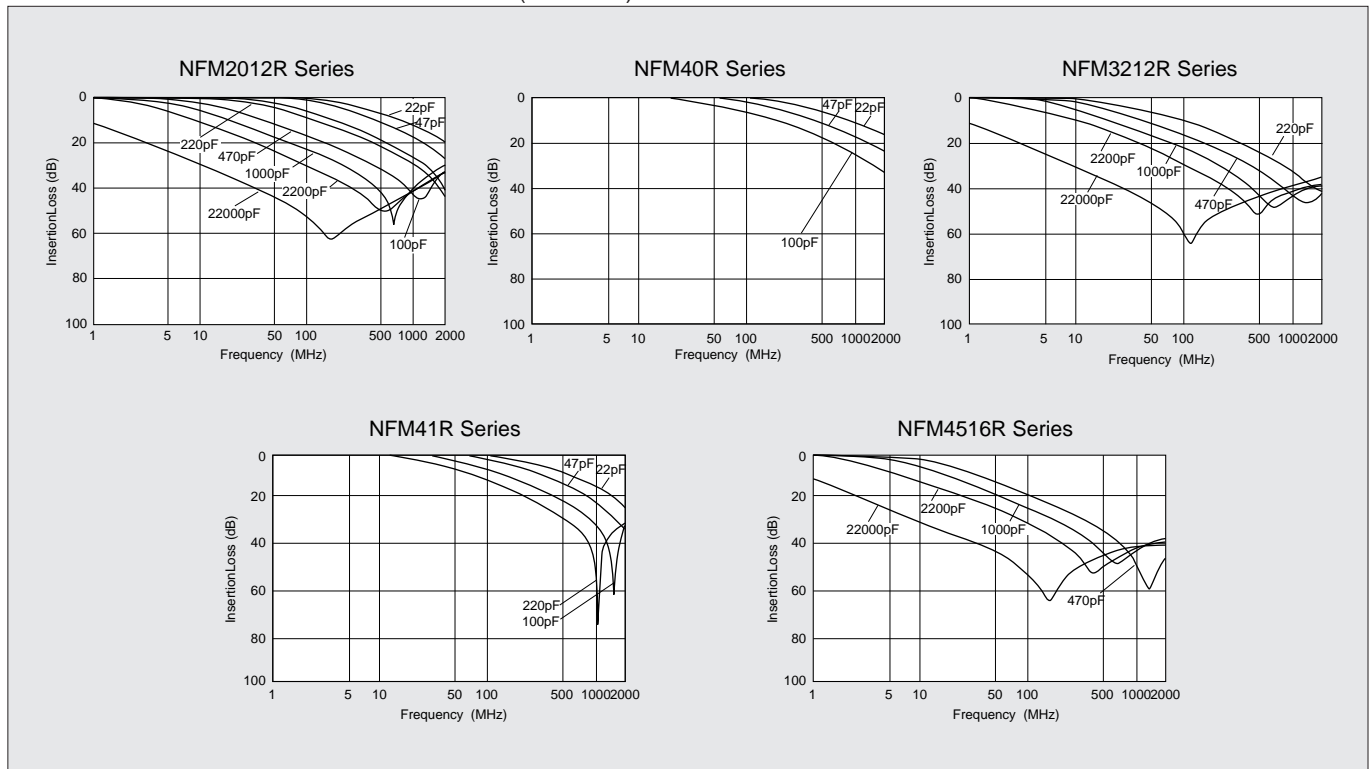

**■ INSERTION LOSS MEASURING CIRCUIT**

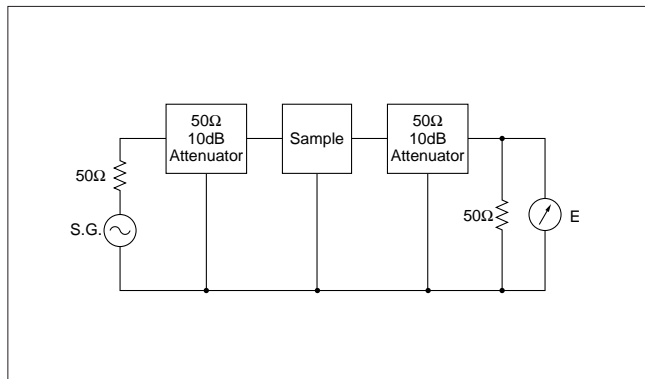

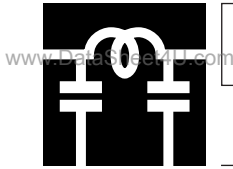

CHIP EMIFIL®

EMIFIL® is the trademark of Murata Manufacturing Co., Ltd.



Chip EMIFIL® Array NFA81R/62R/NFA3216D Series

# 4 Lines 3-Terminal Capacitor are Included in 3.2×1.6mm\* Chip Reducing Mounting Space

The NFA series of chip EMI suppression filters is designed for surface mount applications. 4, 6, or 8 circuits are condensed into one package to enable significant savings in mounting space. The filters feature Murata's original EMI suppression technology as well as an improved design base over the single circuit type NFM series. The series is well suited for EMI suppression in digital I/O lines of varied electronic equipment such as Notebook PCs.

\*NFA3216D

## FEATURES

1. 4, 6, or 8 circuits are available in single packages with either 0.8mm (NFA62R/NFA3216D) or 1.27mm (NFA81R) pitch, making the series excellent for the high density EMI suppression requirement.
2. The 3-terminal structure realizes excellent EMI suppression at high frequencies. The series has a unique internal structure that minimizes crosstalk.
3. The filter has two ground terminals to provide perfect ground conditions for all filter circuits. In this way, excellent EMI suppression in a narrow path can be realized using uncomplicated land designs.
4. The nickel barrier structure of the external electrodes provides excellent solder heat resistance. Both flow and reflow soldering techniques are possible.
5. The series is available in a wide variety of capacitances to meet many of your noise suppression requirements.

## APPLICATIONS

- Computers and peripherals, digital TVs, digital VCRs etc.

## PART NUMBERING

(Please specify the part number when ordering.)

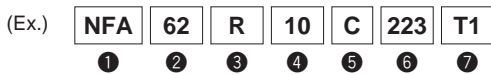

- ① Type
- ② Number of Circuits and Terminal Pitch
  - 81 8 circuit 1.27mm pitch
  - 62 6 circuit 0.80mm pitch
  - 3216 4 circuit 0.80mm pitch
- ③ Monolithic type
- ④ Class No.
- ⑤ Circuit Composition
- ⑥ Characteristics
- ⑦ Packaging Code    T1 : Taped  
                                 B1 : Bulk package

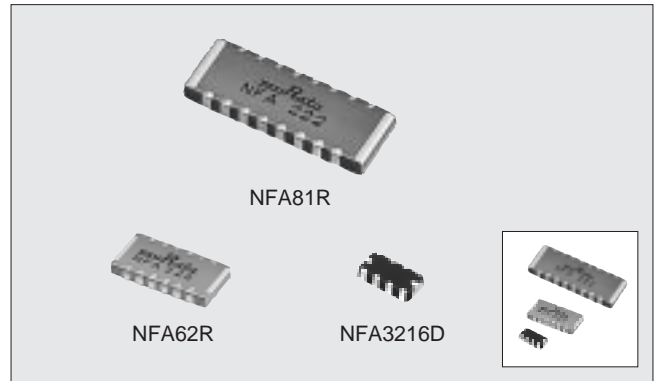

## DIMENSIONS

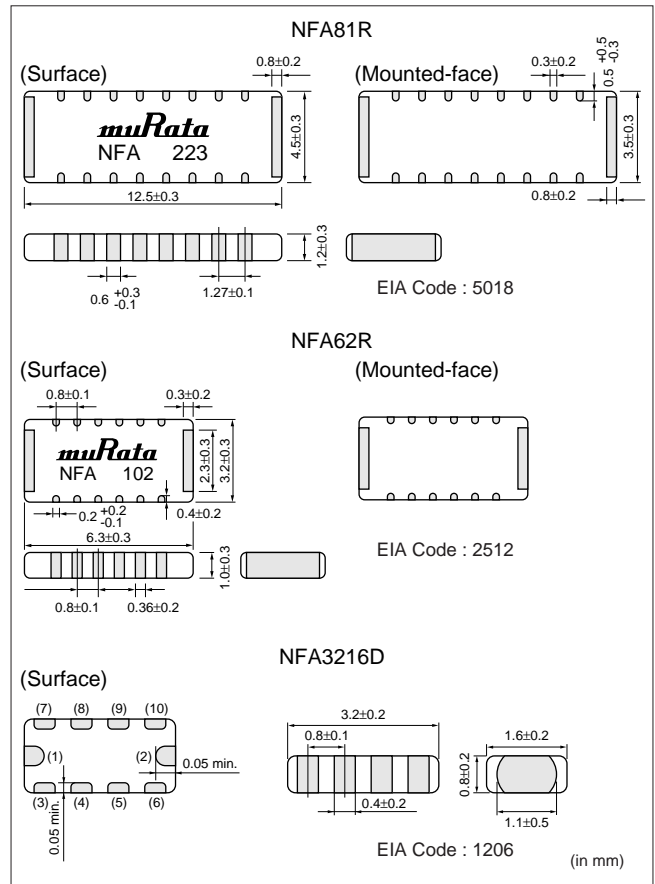

## EQUIVALENT CIRCUIT DIAGRAM

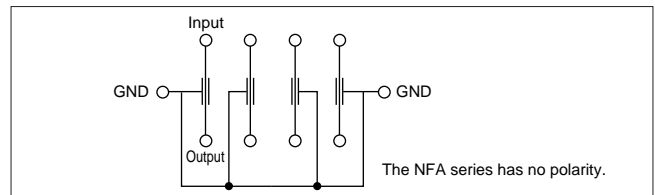

**■SPECIFICATIONS**

Part Number	Capacitance	Rated Voltage	Rated Current	Insulation Resistance	Operating Temp. Range (°C)	Number of Circuit
NFA81R00C220	22pF±50%	50Vdc	300mAdc	1000MΩ min.	-55 to +125	8
NFA81R00C470	47pF±50%					
NFA81R00C101	100pF±50%					
NFA81R00C221	220pF±50%					
NFA81R00C471	470pF±50%		200mAdc			
NFA81R10C102	1000pF±50%					
NFA81R10C222	2200pF±50%					
NFA81R10C223	22000pF±50%					
NFA62R00C220	22pF±50%	50Vdc	200mAdc	1000MΩ min.	-55 to +125	6
NFA62R00C470	47pF±50%					
NFA62R00C101	100pF±50%					
NFA62R00C221	220pF±50%					
NFA62R00C471	470pF±50%					
NFA62R00C102	1000pF±50%					
NFA62R10C222	2200pF±50%					
NFA62R10C223	22000pF±50%					
NFA3216D02C220	22pF±20%	25Vdc	200mAdc	1000MΩ min.	-55 to +85	4
NFA3216D02C470	47pF±20%					
NFA3216D02C101	100pF±20%					
NFA3216D02C221	220pF±20%					
NFA3216D12C471	470pF±20%					
NFA3216D12C102	1000pF±20%					
NFA3216D12C222	2200pF±20%					
NFA3216D12C223	22000pF±20%					



**■INSERTION LOSS CHARACTERISTIC (TYPICAL)**

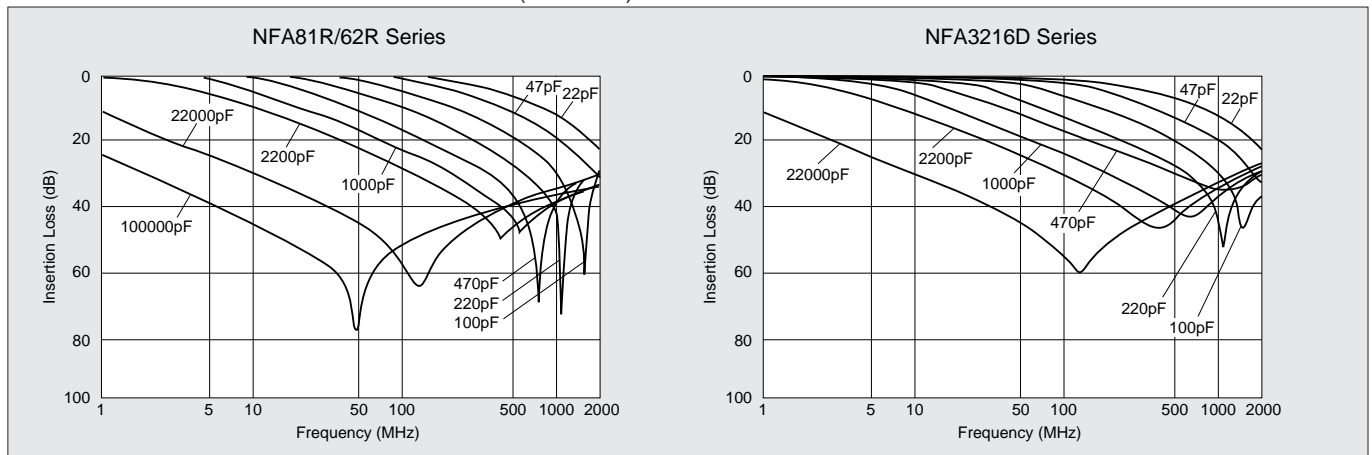

**■INSERTION LOSS MEASURING CIRCUIT**

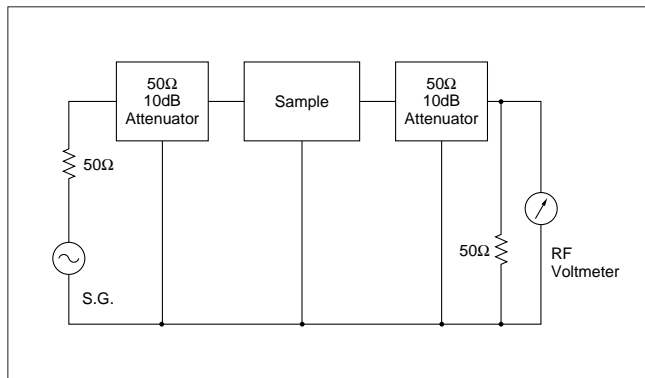

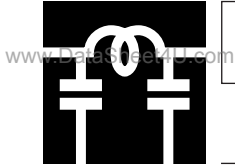

CHIP EMIFIL®

EMIFIL® is the trademark of Murata Manufacturing Co., Ltd.



Chip EMIFIL® Array NFA3216G Series

# 4 lines high performance filter with low distortion are included in 3.2 × 1.6mm size

The NFA3216G series is high performance EMI suppression filter array which designed 4 circuits noise filter in 3.2×1.6 mm size. NFA3216G realizes high density mounting.

## FEATURES

1. NFA3216G has 4 circuits noise filter in 3.2×1.6 mm size with 0.8mm pitch. High density mounting is available.
2. 3 terminal structure is achieved excellent high frequency performance.
3. Distributed constant circuit realizes smooth change of impedance which prevents reflection of signal and distortion of wave shape.
4. NFA3216G series is effective in the line where ground is not stable, because the resistance element in the filter absorb noise and return it to ground line.

## APPLICATIONS

- Suppression of noise in LCD driver or bus line of compact size digital equipment (Such as note book size PC, PDA and other)

## PART NUMBERING

(Please specify the part number when ordering.)

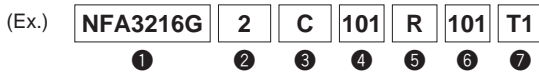

- ① Type
- ② Class No.
- ③ Circuit Composition
- ④ Capacitance
- ⑤ Circuit Composition
- ⑥ Resistance
- ⑦ Packaging Code    T1 : Taped  
                                  B1 : Bulk package

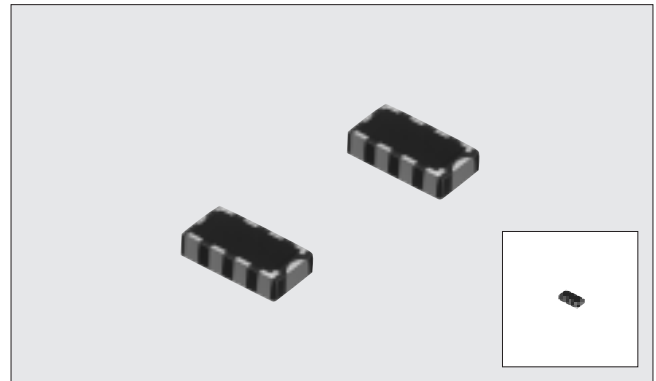

## DIMENSIONS

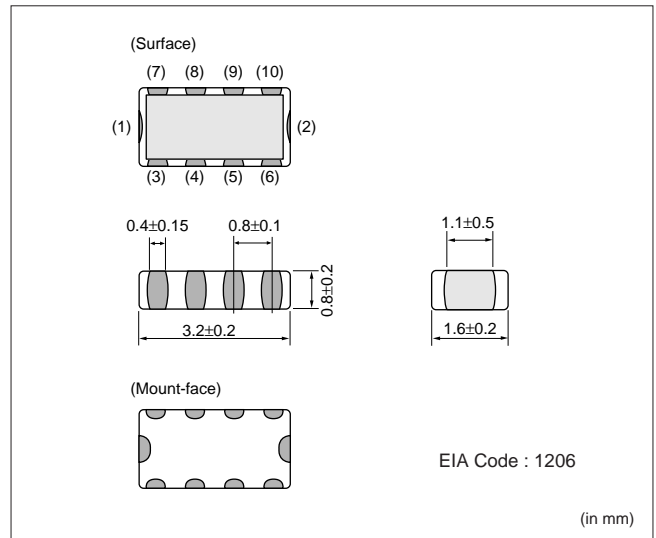

## EQUIVALENT CIRCUIT DIAGRAM

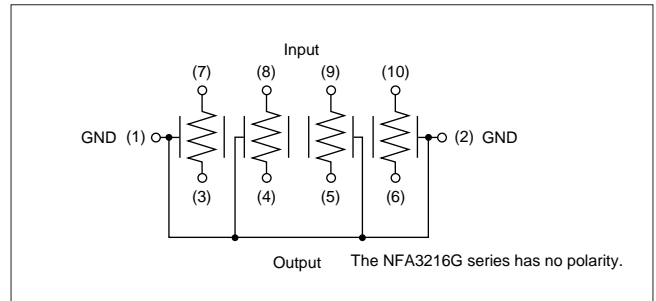

**■ SPECIFICATIONS**

Part Number	Capacitance (pF)	Resistance (Ω)	Rated Current (mA) Signal line	Rated Voltage (Vdc)	Insulation Resistance (MΩ) Signal line-Ground	Operating Temp. Range (°C)
NFA3216G2C100R6R8	10±20%	6.8±40%	50	6	1000 min.	-40 to +85
NFA3216G2C100R470		47±30%	20			
NFA3216G2C100R101		100±30%	15			
NFA3216G2C470R6R8	47±20%	6.8±40%	50			
NFA3216G2C470R470		47±30%	20			
NFA3216G2C470R101		100±30%	15			
NFA3216G2C101R6R8	100±20%	6.8±40%	50			
NFA3216G2C101R470		47±30%	20			
NFA3216G2C101R101		100±30%	15			

**■ INSERTION LOSS CHARACTERISTIC (TYPICAL)**

Resistance 6.8Ω line up

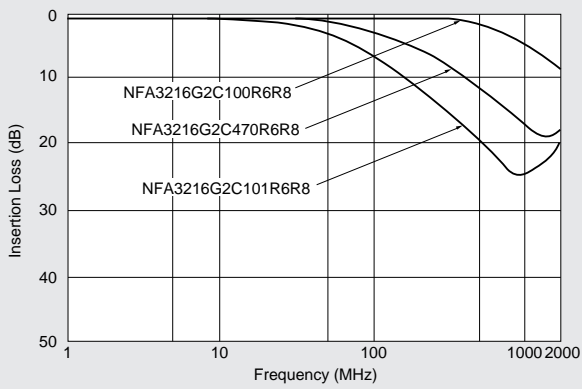

Resistance 47Ω line up

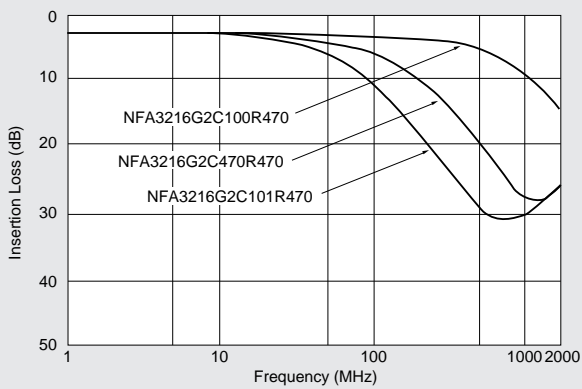

Resistance 100Ω line up

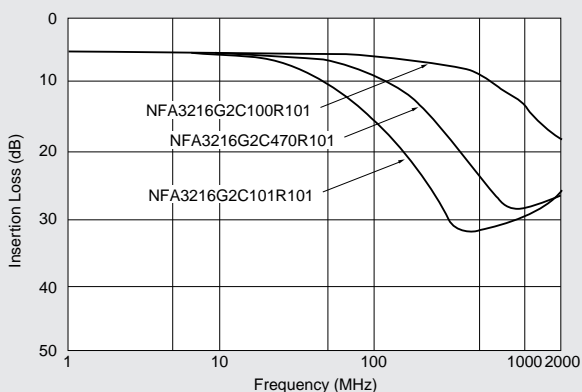

**■ INSERTION LOSS MEASURING CIRCUIT**

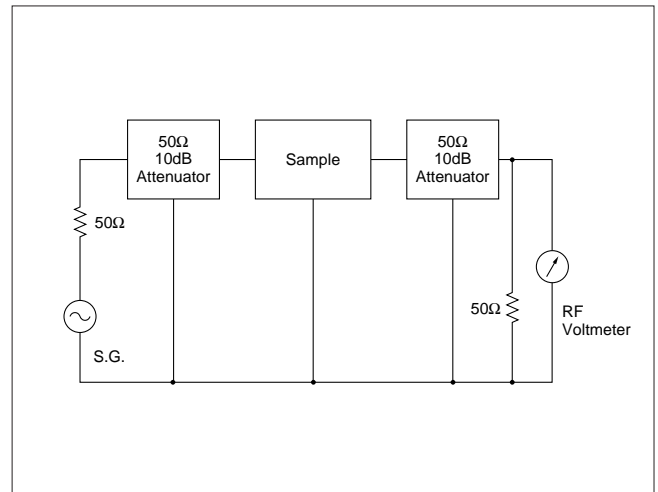

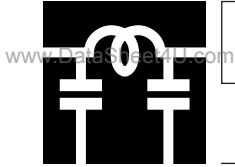

CHIP EMIFIL®

EMIFIL® is the trademark of Murata Manufacturing Co., Ltd.



Chip EMIFIL® NFM839R Series

# Distributed Constant Circuit Type Chip EMIFIL® which Prevent Wave Distortion

The NFM839R series comprise high performance EMI suppression filter which can suppress distortion of waveform. The NFM839R series can be used in interface lines and clock lines where signals are tend to be distorted. The NFM839R series has various line up of resistance (22-100Ω) and capacitance (10-100pF). Various items are to be used, considering circuit impedance and noise condition.

### ■FEATURES

1. MURATA's original inner design realized small and low profile of 2.0mm×1.25mm×0.5mm.
2. Distributed constant circuit realizes smooth change of impedance which prevents reflection of signal and distortion of wave shape.
3. The NFM839R series is effective in the line in which ground is not stable because the resistance element in the filter absorb noise and return it to ground line.
4. The NFM839R series has no polarity so that it can be used in dual direction transport lines.

### ■APPLICATIONS

- Suppression of noise in interface line or clock line of digital equipment (such as personal computers, word processors)

### ■PART NUMBERING

(Please specify the part number when ordering.)

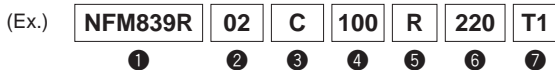

- ① Type
- ② Class No.
- ③ Circuit Composition
- ④ Capacitance
- ⑤ Circuit Composition
- ⑥ Resistance
- ⑦ Packaging Code    T1 : Taped  
                              B1 : Bulk package

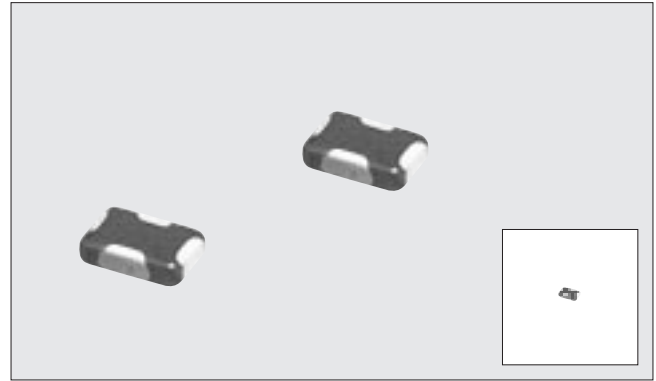

### ■DIMENSIONS

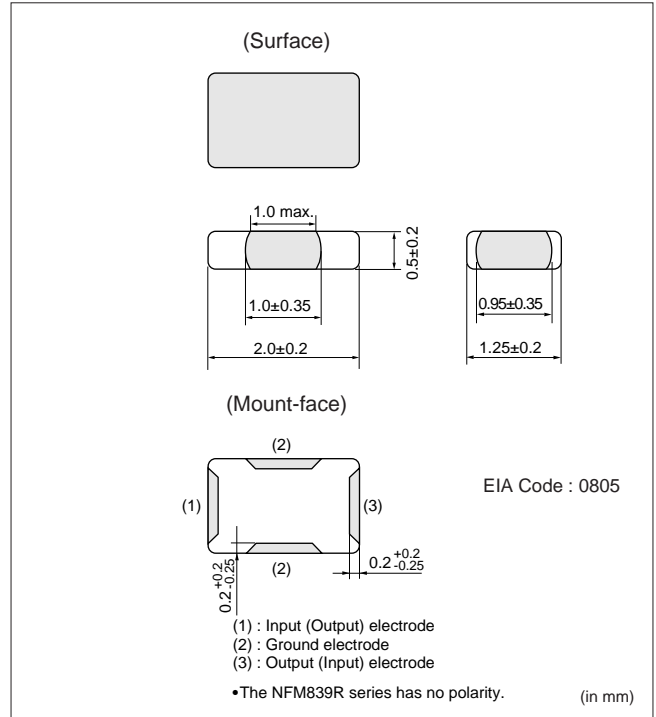

### ■EQUIVALENT CIRCUIT DIAGRAM

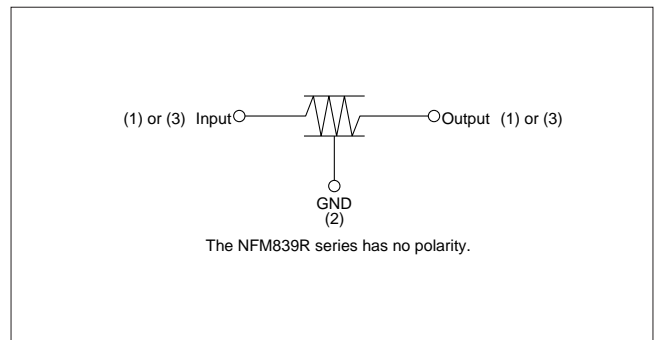



**■ SPECIFICATIONS**

www.DataSheet4U.com

Part Number	Capacitance (pF)	Resistance (Ω)	Rated Current (mA) (1) - (3)	Rated Voltage (Vdc) (1) (3) - (2)	Insulation Resistance (MΩ) (1) (3) - (2)	Operating Temp. Range (°C)
NFM839R02C100R220	10±20%	22±30%	50	50	1000min.	-40 to +85
NFM839R02C100R470		47±30%	35			
NFM839R02C470R220	47±20%	22±30%	50			
NFM839R02C470R470		47±30%	35			
NFM839R02C470R680		68±30%	30			
NFM839R02C470R101		100±30%	25			
NFM839R02C101R220	100±20%	22±30%	50			
NFM839R02C101R470		47±30%	35			
NFM839R02C101R680		68±30%	30			
NFM839R02C101R101		100±30%	25			

**■ INSERTION LOSS CHARACTERISTICS (TYPICAL)**

● For High Impedance Line (Measured with 50Ω-3kΩ lines)

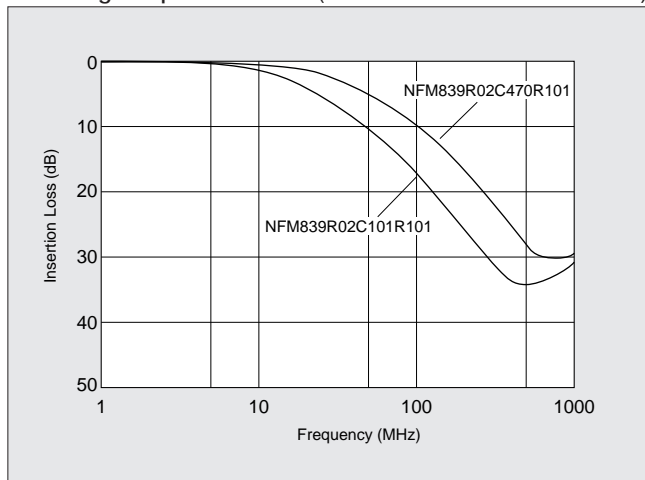

● For Low Impedance Line (Measured with 50Ω-150Ω lines)

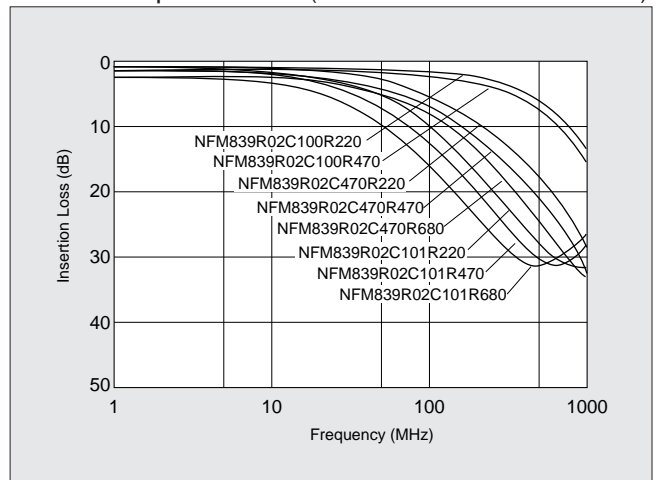

**■ INSERTION LOSS MEASURING CIRCUITS**

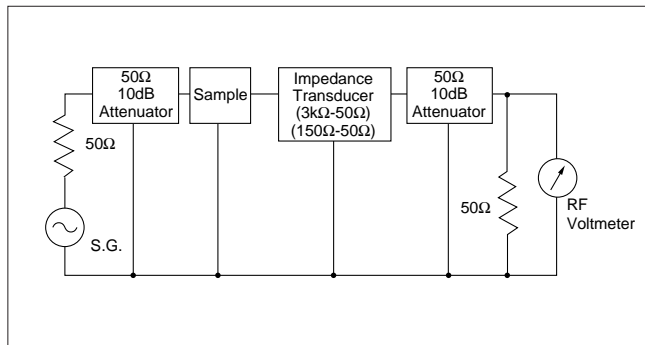

**■EFFECT OF NOISE SUPPRESSION BY NFM839R**

The NFM839R is effective even if ground line is not stable enough due to its distribute constant circuit structure.

**■TESTING CIRCUIT**

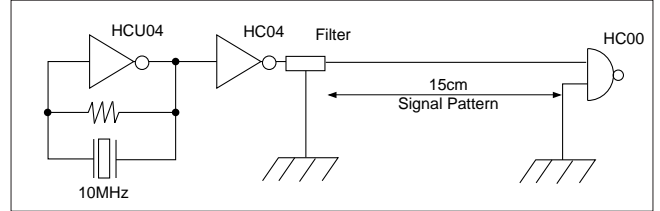

**With Stable Ground Line**

● Noise Level without Filter

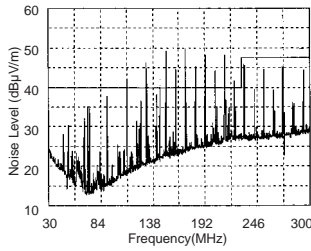

Standard Type Chip EMIFIL® (100pF)

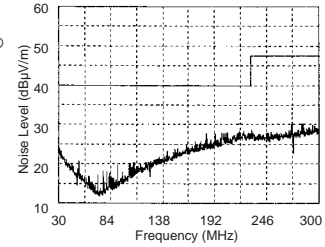

The standard type chip EMIFIL® is effective on stable ground line.

● Filter Mounting Condition

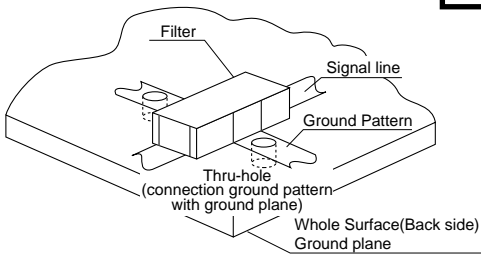

NFM839R02C470R101

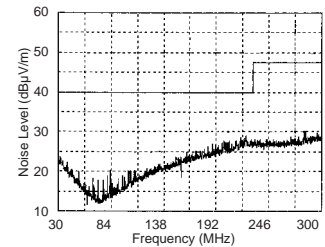

The NFM839R has some advantage to standard type EMIFIL® on stable ground line.

**With Poor Ground Line**

● Noise Level without Filter

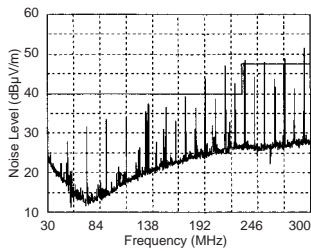

Standard Type ChipEMIFIL® (100pF)

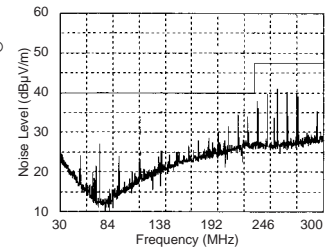

The standard type EMIFIL® lose efficiency on poor ground line.

● Filter Mounting Condition

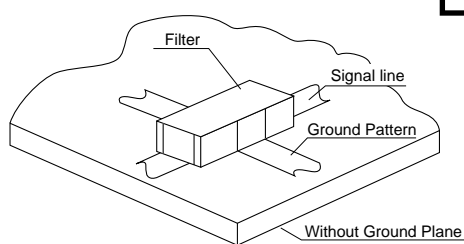

NFM839R02C470R101

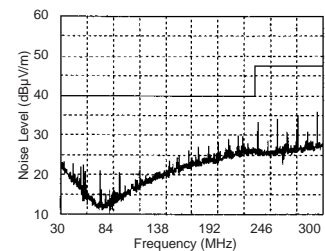

The NFM839R is effective even on poor ground line because of its distribute constant circuit structure and unique system to limit rush current.

**WAVEFORM DISTORTION SUPPRESSING FUNCTION BY NFM839R**

**Testing Circuit**

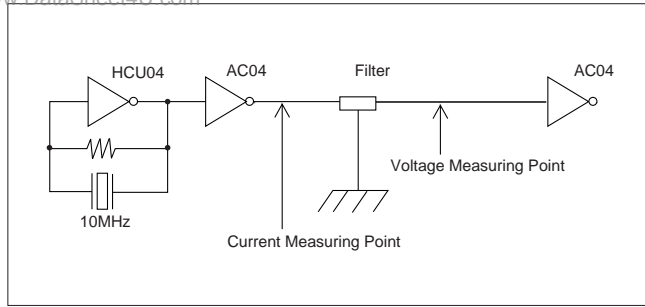

**Initial Waveform (no filter)**

**Voltage Waveform**

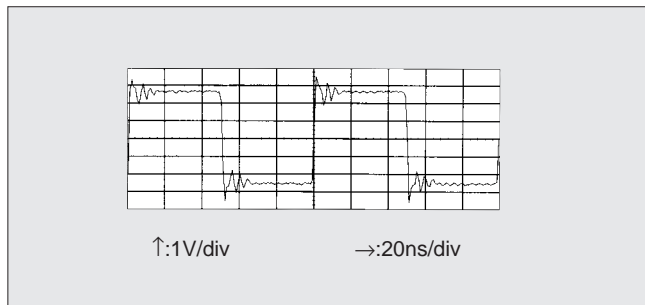

Resonance between the internal capacitance of the IC and the inductance of the print pattern causes waveform overshooting and undershooting.

**Current Waveform**

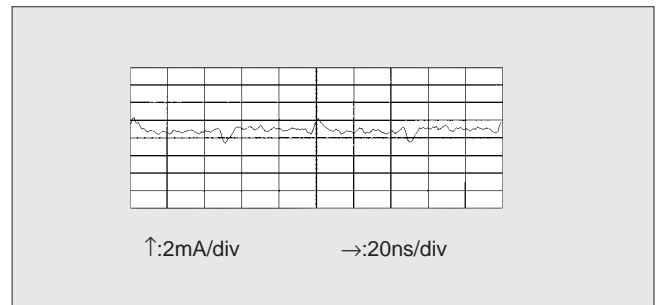

**When Ordinary Capacitor Filter is Used**

**Output Voltage Waveform**

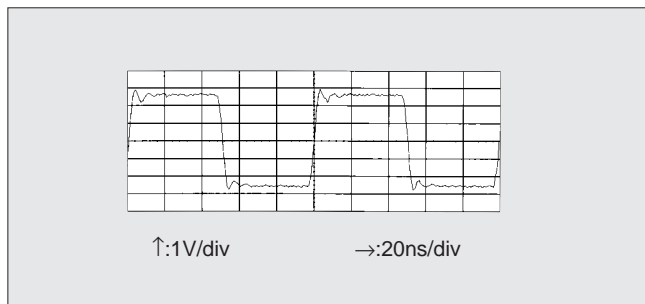

Ordinary capacitor filters have no waveform distortion suppressing capability, and they cannot suppress disturbances in the waveforms.

**Input Current Waveform**

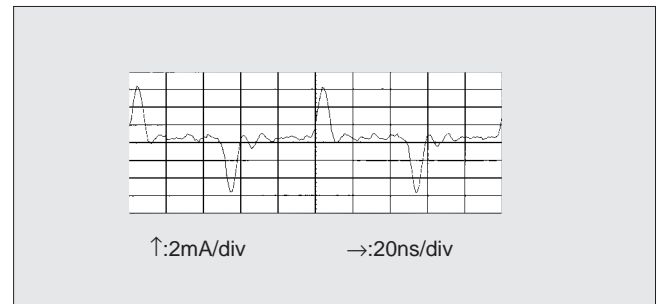

The current needed to charge and discharge the capacitor raises the peak level of current that flows out of the driver side IC, increasing the load on the IC.

**NFM839R**

**Output Voltage Waveform**

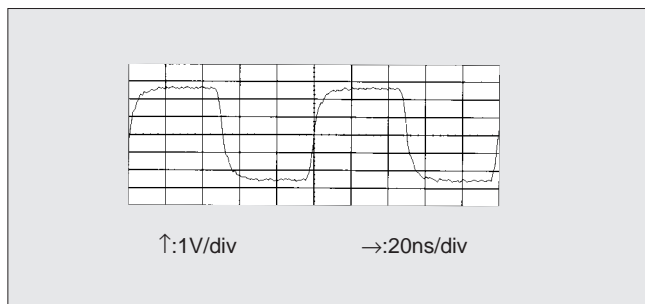

The waveform distortion suppressing function of the NFM839R minimizes disturbances of waveforms.

**Input Current Waveform**

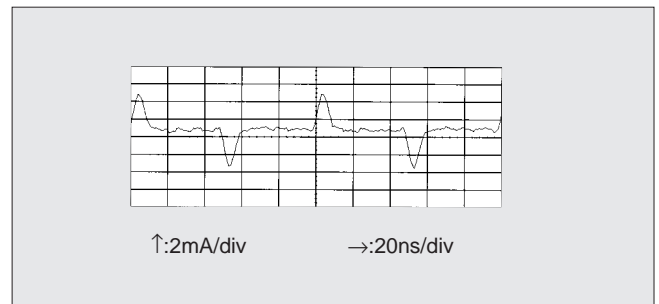

The NFM839R also includes a current limiting function, reducing the load on driver ICs.

2

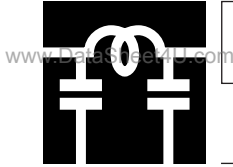

**CHIP EMIFIL®**

EMIFIL® is the trademark of Murata Manufacturing Co., Ltd.



Chip EMIFIL® for Signal Line **NFM51R** Series

# 100dB/dec. (typ.) Damping Characteristics for High Speed Signal Line

The signal line chip EMIFL® NFM51R series consist of high performance EMI suppression filters. They are designed for noise suppression in high speed digital circuits in which the signal harmonics are prone to becoming noise sources.

These filters achieve a 100dB/dec. (typ.) damping characteristic made possible by Murata's innovative circuit design. This makes these chips effective in applications where the signal and noise frequencies are close to each other.

### ■FEATURES

1. The filters suppress signal noise with little or no attenuation of the signal itself.
2. Murata's original internal structure design enables excellent noise suppression up to high frequencies (40dB at 1GHz typ.).
3. The NFM51R series is available in six different values of cutoff frequency ranging from 10MHz up to 500MHz.

### ■APPLICATIONS

- Suppression of high magnitude radiated noise generated by high speed digital circuits such as clock and RGB circuits
- Suppression of noise in high speed processing circuits such as digital image signal processing circuits

### ■PART NUMBERING

(Please specify the part number when ordering.)

(Ex.) **NFM51R** **00P** **506**  
①      ②      ③

- ① Type
- ② Class No.
- ③ Cut-off Frequencies

### ■SPECIFICATIONS

Part Number	Cut-off Frequency (MHz)	Attenuation (dB min.)										Rated Voltage (Vdc)	Rated Current (mA)	Operating Temp. Range (°C)
		10MHz	20MHz	50MHz	100MHz	150MHz	200MHz	300MHz	400MHz	500MHz	1GHz			
NFM51R00P106	10	*	5	25	25	-	25	-	-	30	30	25	200	-40 to +85
NFM51R00P206	20	-	*	5	25	-	25	-	-	30	30			
NFM51R00P506	50	-	-	*	10	-	30	-	-	30	30			
NFM51R10P107	100	-	-	-	*	-	5	-	-	20	30			
NFM51R10P157	150	-	-	-	-	*	-	10	20	30	30			
NFM51R20P207	200	-	-	-	-	-	*	-	-	10	30			
NFM51R30P307	300	-	-	-	-	-	-	*	-	5	15			
NFM51R30P407	400	-	-	-	-	-	-	-	*	-	10			
NFM51R30P507	500	-	-	-	-	-	-	-	-	*	10			

\*6dB max.

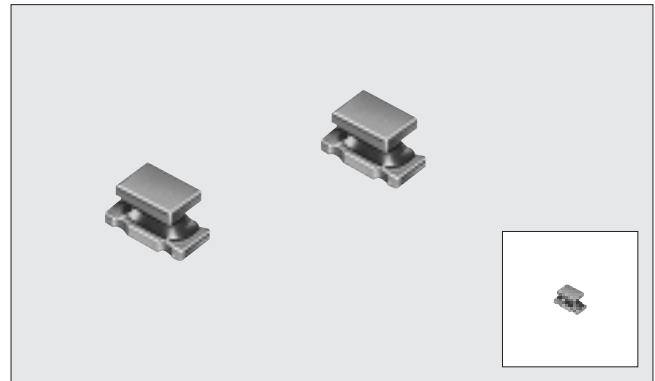

### ■DIMENSIONS

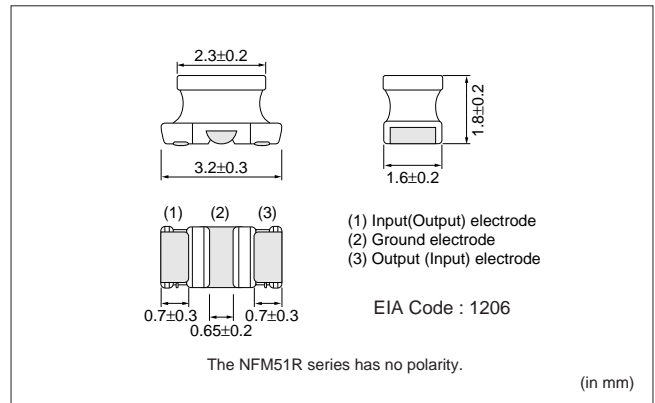

**■ INSERTION LOSS CHARACTERISTICS (TYPICAL)**

www.DataSheet4U.com

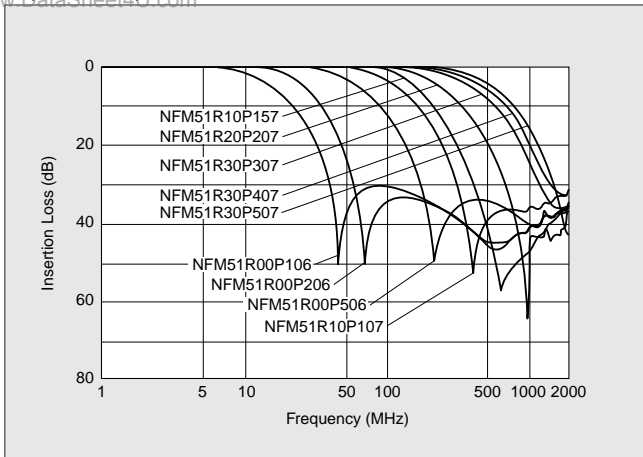

**■ INSERTION LOSS MEASURING CIRCUIT**

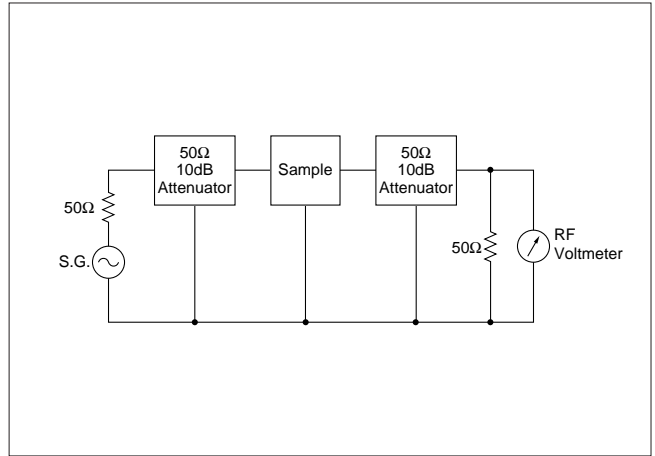

- Comparison with Conventional Chip EMIFIL®  
NFM51R series can realize EMI suppression without reducing effective elements of the signal, because it has steep attenuation characteristics.

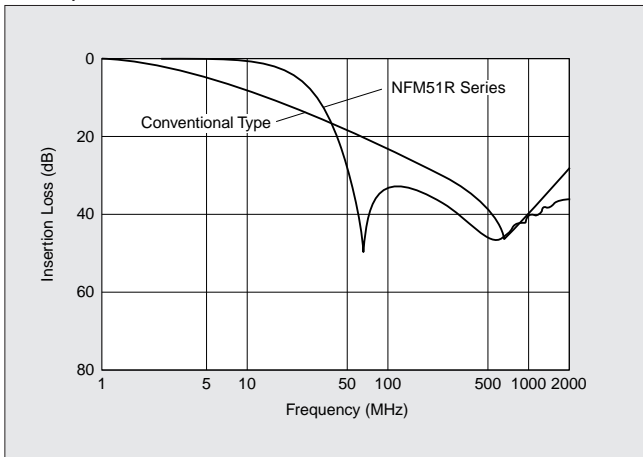

2

**EXAMPLE OF EMI SUPPRESSION  
IN AN ACTUAL CIRCUIT**

www.DataSheet4U.com

● Measuring Circuit

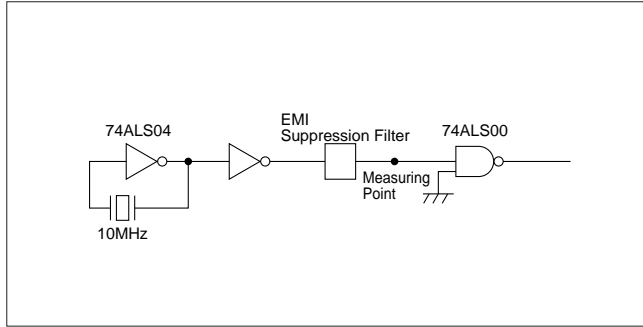

● Signal Waveform and Noise Spectrum before Filter Mounting

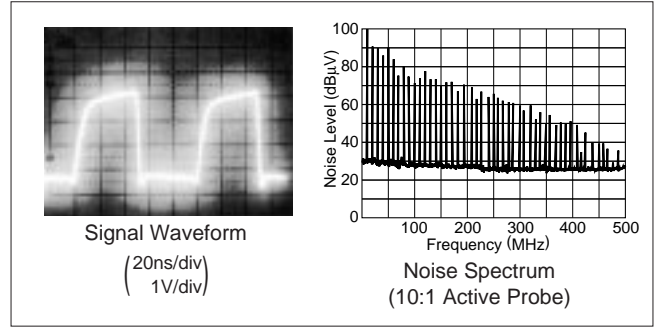

● Waveform Change and Noise Suppression Effect when Filter is Inserted

Type of Filter	Signal Wave Form (20ns · 1V/div)	EMI Suppression Effect	Description
NFM51R Series (Cut-off frequency 50MHz)			The NFM51R's steep attenuation characteristic means excellent EMI suppression without waveform cornering.
Conventional Chip Solid type EMI Filter (NFM41R 470pF)			3-terminal capacitors suppress signal frequencies as EMI frequencies so the signal waveform is distorted.
Filter Combined with Conventional LCs	 L : Chip Inductor C : Chip Capacitor (270pF)		Combinations of inductors and capacitors can yield a steep attenuation characteristic, but they require a great deal more mounting space. Moreover, at high frequencies the EMI suppression is less than that obtained by the NFM51R.

2

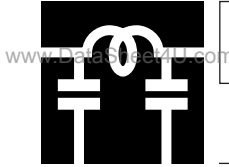

CHIP EMIFIL®

EMIFIL® is the trademark of Murata Manufacturing Co., Ltd.



Chip Solid EMIFIL® NFM2012P/40P/4516P/46P

# Large Rated Current 3 Terminal Capacitor in DC Power Line

Chip solid EMIFIL® NFM2012P\*/40P/4516P\*/46P are 3 terminal structure SMT components. These components are able to be applied to large current DC power lines. NFM2012P/40P/4516P/46P are suitable in noise suppression DC lines where relatively large currents operate.

\*Using base metal to the electrode.

## FEATURES

- NFM2012P
  1. The rated current of 2A-4A is suitable for IC's individual power line.
  2. Small dimension enables higher density packaging. NFM2012P is much smaller size. (2.0×1.25×0.85mm)
  3. Murata's original internal electrode structure design which realizes excellent EMI suppression effect from low frequency to high frequency.
- NFM40P/4516P/46P
  1. Large rated current (NFM40P/4516P : 2A, NFM46P : 6A) and low voltage drop due to a small DC resistance are suitable for the application in DC power line.
  2. High electrostatic capacitance and remarkable high frequency performance are effective for the immunity against the surge noise and the pulse noise.
  3. Only reflow soldering should be applied.(NFM46P)

## APPLICATIONS

- Personal computers, Word processors and Peripherals
- Telephones, PPCs, Communication equipments, etc.
- Digital TVs, VCRs
- Telecommunication equipment

## PART NUMBERING

(Please specify the part number when ordering.)

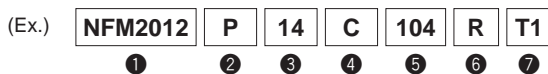

- ① Type
- ② Large Current
- ③ Class No.
- ④ Circuit Composition
- ⑤ Capacitance
- ⑥ Other Characteristics (NFM2012P/NFM4516P)
- ⑦ Packaging Code T1 : Taped  
B1 : Bulk package

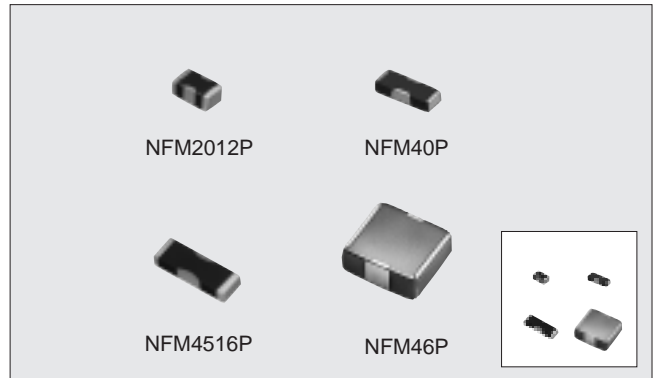

## DIMENSIONS

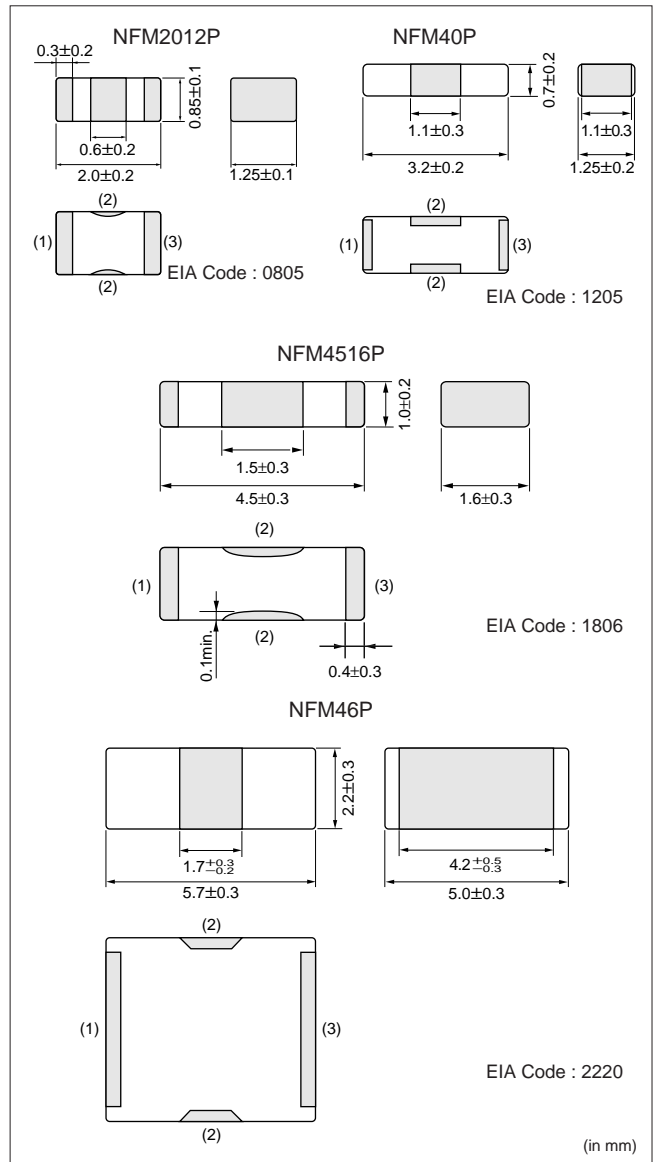

**■SPECIFICATIONS**

www.DataSheet4U.com

Part Number	Capacitance	Rated Voltage (Vdc)	Rated Current (Adc)	Insulation Resistance (MΩ min.)	DC Resistance (1) - (3) (Ω max.)	Operating Temp. Range (°C)
NFM2012P13C105B	1000000pF±20% (1μF)	10	4	500	0.02	-40 to +85
NFM2012P13C105F	1000000pF±20% (1μF)	16	2		0.03	
NFM2012P13C474R	470000pF±20% (0.47μF)					
NFM2012P13C224R	220000pF±20% (0.22μF)					
NFM2012P14C104R	100000pF±20% (0.1μF)	25	50	1000	0.05	-55 to +85
NFM40P12C223	22000pF±20%					
NFM4516P13C204F	200000pF±20% (0.2μF)	50	6	100	0.04	
NFM46P11C155	1.5μF ±20%				0.01	

**■INSERTION LOSS CHARACTERISTIC (TYPICAL)**

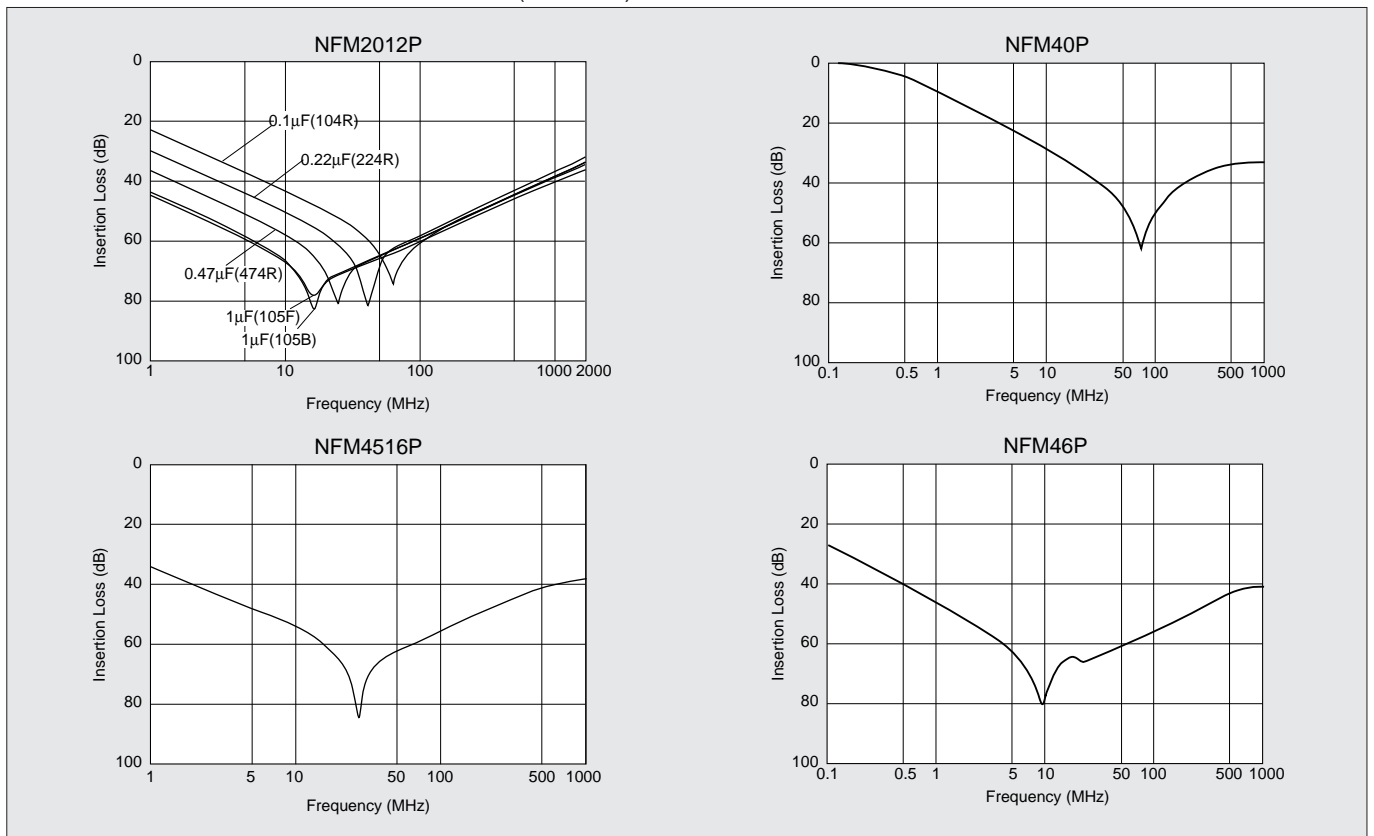

**■EQUIVALENT CIRCUIT DIAGRAM**

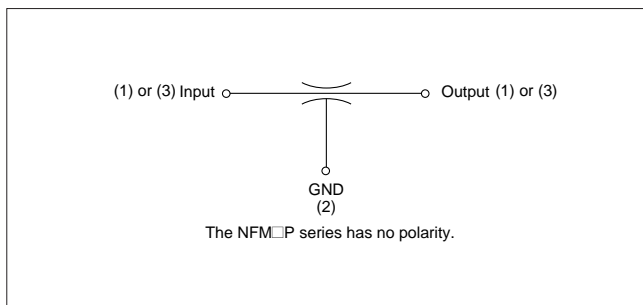

**■INSERTION LOSS MEASURING CIRCUIT**

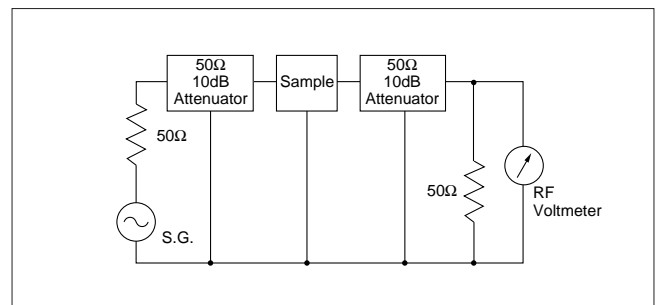



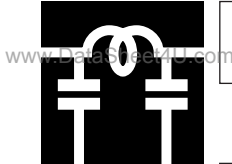

CHIP EMIFIL®

EMIFIL® is the trademark of Murata Manufacturing Co., Ltd.



T-type Chip EMIFIL® NFM60R/61R/61RH Series

# Meets High Current of 6A T-Type Circuit Chip EMIFIL® with Ferrite Beads

## ■FEATURES

1. Its large rated current and low voltage drop due to small DC resistance are suitable for DC power line use.
2. The feedthrough capacitor realized excellent high-frequency characteristics.
3. The structure incorporates built-in ferrite beads which minimize resonance with surrounding circuits.
4. For rugged operating environments such as automobile circuitry, Murata offers the heavy duty NFM61RH series. These filters have an extended operating temperature range of -55°C to +125°C.

## ■APPLICATIONS

- Office equipment such as personal computers, word processors and facsimiles
- Audio visual equipment such as TVs and VCRs

## ■PART NUMBERING

(Please specify the part number when ordering.)

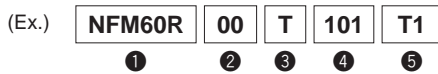

- ① Type
- ② Class No.
- ③ Circuit Composition
- ④ Characteristics
- ⑤ Packaging Code    T1 : Taped  
                              B1 : Bulk package

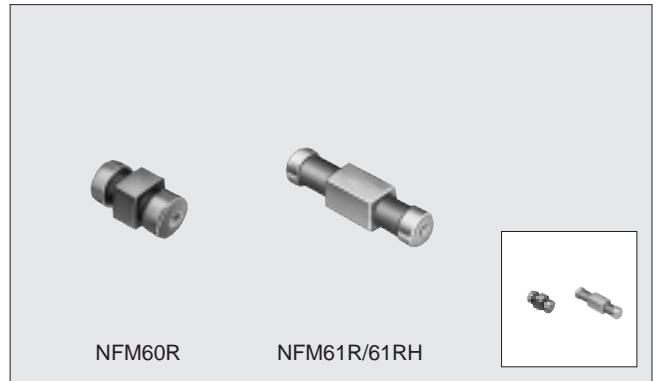

## ■DIMENSIONS

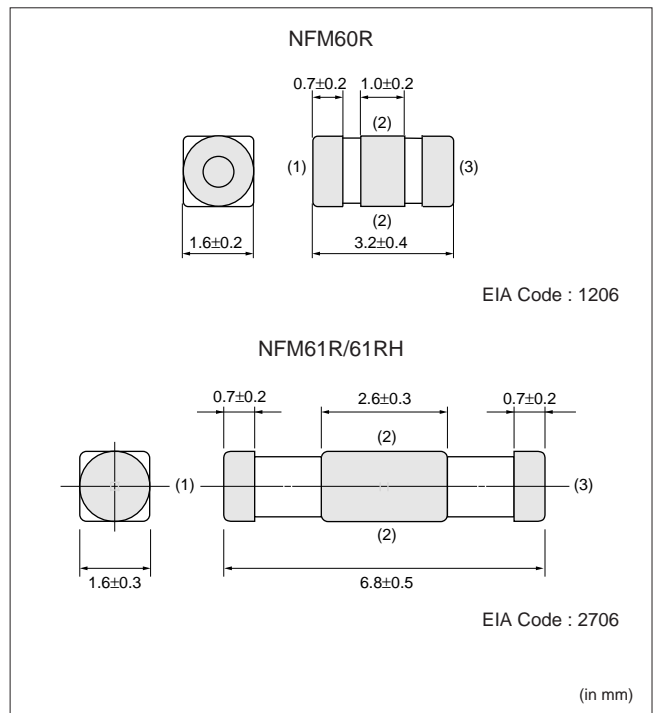

## ■EQUIVALENT CIRCUIT DIAGRAM

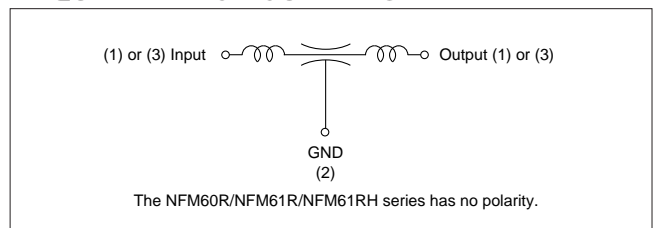

**■SPECIFICATIONS**

**NFM60R Series (Compact Size Type)**

Part Number	Capacitance	Rated Voltage	Rated Current	Insulation Resistance	Operating Temp. Range
NFM60R00T220	22pF±30%	25Vdc	6Adc	1000MΩ min.	-40°C to +85°C
NFM60R00T470	47pF±30%				
NFM60R00T101	100pF±30%				
NFM60R00T221	220pF±30%				
NFM60R10T471	470pF±30%				
NFM60R20T152	1500pF±30%				
NFM60R30T222	2200pF±50%				

**NFM61R Series**

Part Number	Capacitance	Rated Voltage	Rated Current	Insulation Resistance	Operating Temp. Range
NFM61R00T330*	33pF±30%	50Vdc	2Adc	1000MΩ min.	-25°C to +85°C
NFM61R00T680*	68pF±30%				
NFM61R00T101	100pF±30%				
NFM61R00T181	180pF±30%				
NFM61R00T361	360pF±20%				
NFM61R00T681*	680pF±30%				
NFM61R10T102	1000pF±30%				
NFM61R30T472	4700pF±30%				

**NFM61RH Series (Heavy Duty Type)**

Part Number	Capacitance	Rated Voltage	Rated Current	Insulation Resistance	Operating Temp. Range
NFM61RH00T330*	33pF±30%	100Vdc	2Adc	1000MΩ min.	-55°C to +125°C
NFM61RH00T680*	68pF±30%				
NFM61RH00T101	100pF±30%				
NFM61RH00T181	180pF±30%				
NFM61RH00T361	360pF±20%				
NFM61RH00T681*	680pF±30%				
NFM61RH10T102	1000pF±30%				
NFM61RH20T332*	3300pF±30%				

\* Marked items are not standard.

**■INSERTION LOSS CHARACTERISTICS (TYPICAL)**

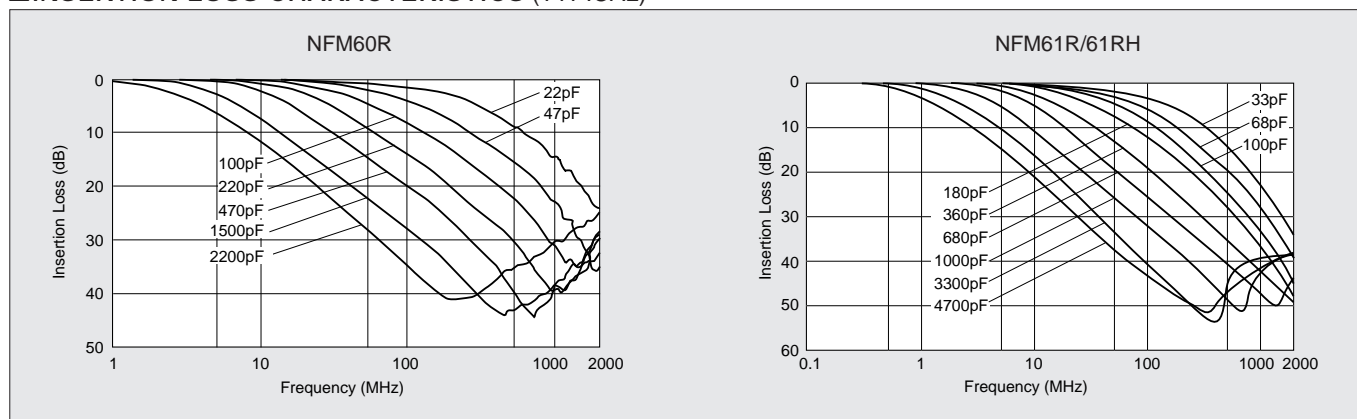

**■INSERTION LOSS MEASURING CIRCUIT**

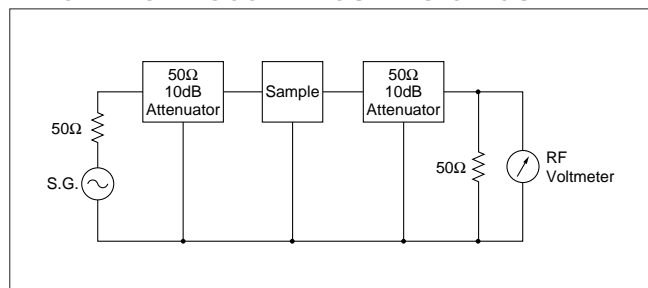

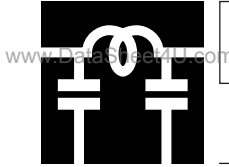

CHIP EMIFIL®

EMIFIL® is the trademark of Murata Manufacturing Co., Ltd.



Chip Solid EMIGUARD® VFM41R Series

# 3-Terminal Varistor-Capacitor EMI Filter

The VFM41R series is a chip EMIFIL® with varistor function. Its 3-terminal structure provides high performance by suppressing high-frequency noise and absorbing surge noise.

## FEATURES

1. The VFM41R series protect semiconductor unit from surge noise such as electrostatic discharge.
2. The VFM41R series suppress EMI noise in signal lines.
3. Chip shape enables high density mounting.

## APPLICATIONS

- ESD surge protection and EMI suppression in various electric equipments such as car electronic equipments, portable electronic equipments, telecommunication terminals, office automation equipments, home automation equipments or factory automation equipments

## PART NUMBERING

(Please specify the part number when ordering.)

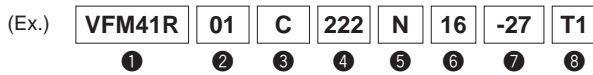

- ① Type
- ② Class No.
- ③ Circuit Composition
- ④ Capacitance
- ⑤ Capacitance Tolerance
- ⑥ Rated Voltage
- ⑦ Varistor Voltage
- ⑧ Packaging Code    T1 : Taped  
                              B1 : Bulk package

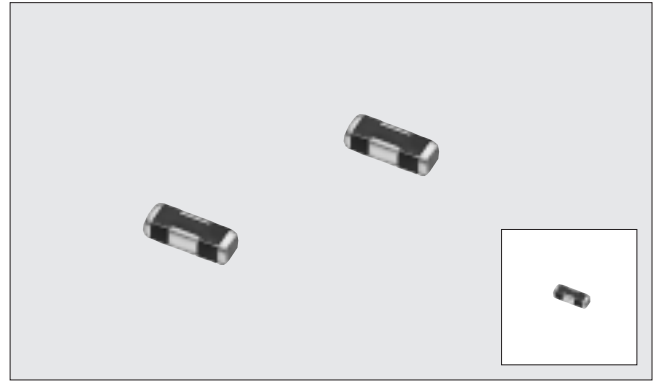

## DIMENSIONS

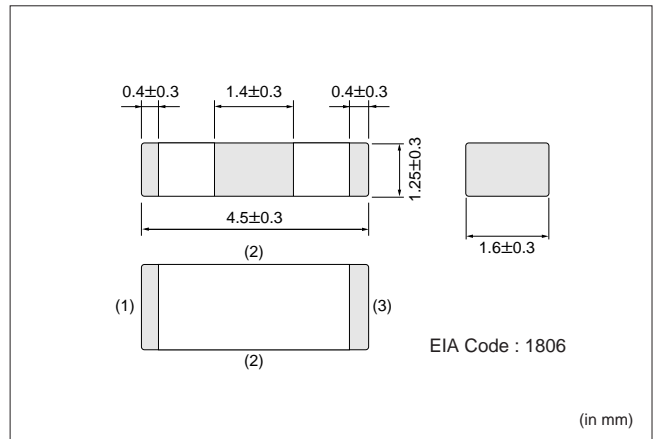

## EQUIVALENT CIRCUIT DIAGRAM

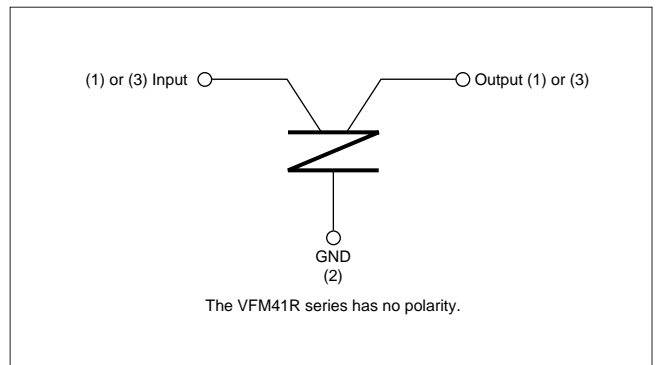

## SPECIFICATIONS

Part Number	Rated Voltage (Vdc)	Varistor Voltage (V)	Rated Current (mA)	Peak Pulse Current (A)	ESD Test (150pF, 330Ω)	Capacitance	Insulation Resistance (MΩ)	Operating Temp. Range (°C)
VFM41R01C222N16-27	16	27±5	200	50	25kV, 10times	2200pF±30%	10min.	-40 to +125

■ INSERTION LOSS CHARACTERISTIC (TYPICAL)

www.DataSheet4U.com

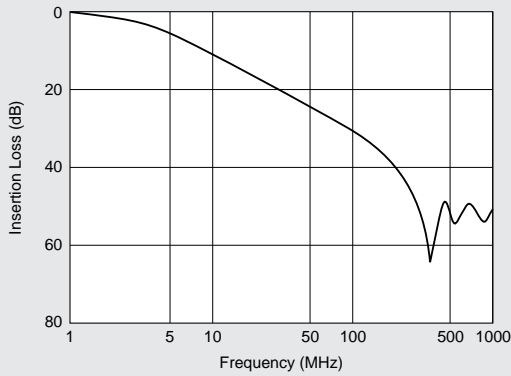

■ INSERTION LOSS MEASURING CIRCUIT

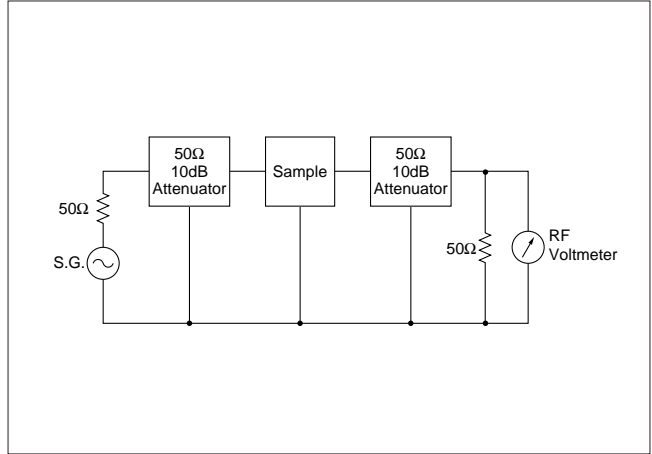

■ IMPULSE NOISE ABSORPTION (Comparison between VFM41R and Standard 2-terminal Varistor)

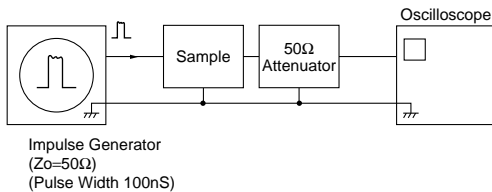

Impulse Generator  
( $Z_o=50\Omega$ )  
(Pulse Width 100nS)

Output Waveform

\* Final voltage comes below 0V because of the affect of signal reflection.

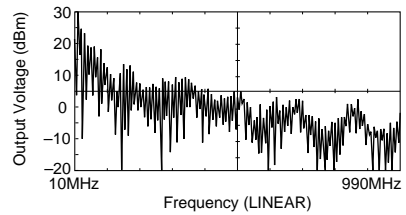
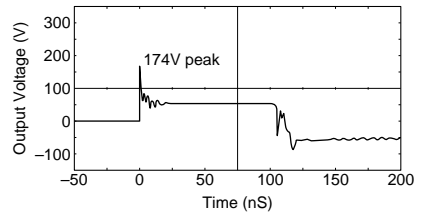

The commonly used 2-terminal varistor

The rising part of pulse, which is mostly consists of high-frequency element, remains because inductance in electrodes becomes obstacle.

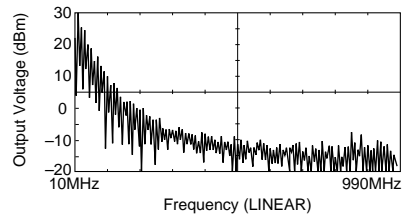
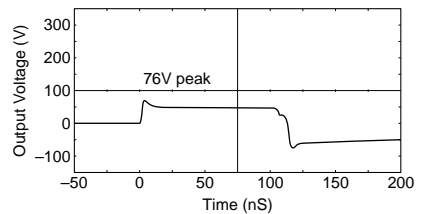

Chip Solid EMIGUARD® VFM41R

The 3-terminal structure minimizes the effect of inductance in electrodes and pulse rising noise is absorbed completely.

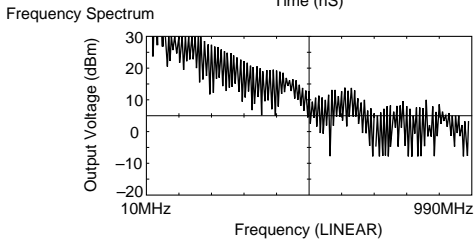
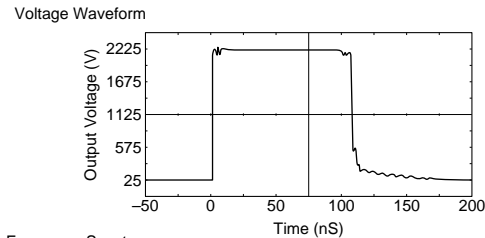

Original Waveform

The Lower chart is a frequency response of the upper chart. Note that the scale of original wave chart and that of the output wave chart is different because of circumstances.

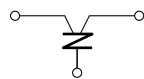
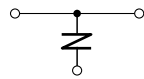

Output Waveform

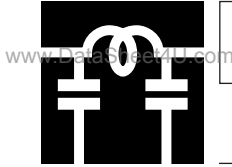

CHIP EMIFIL®

EMIFIL® is the trademark of Murata Manufacturing Co., Ltd.



Thin Film Type Chip Common Mode Choke Coil **PLP3216S** Series

# Thin Film Type Chip Common Mode Chock Coil with High Impedance at High Frequency in Small Size Suitable for USB

The PLP3216S series is chip common mode choke coil that is realized high impedance in small size with ferrite material technology and thin film processing. The PLP3216S has excellent performance at high frequency range. PLP3216S is suitable for differential signal line application.

## FEATURES

1. PLP3216S is common mode choke coil that realized small size, low profile, SMD. 3.2×1.6×1.15mm (tolerance:0.15mm)
2. PLP3216S has high common mode impedance (550Ω typ. at 100MHz) in small size.
3. PLP3216S suppress high frequency noise that was unable to be suppressed with existing common mode choke coils.  
Suitable for differential signal line as like USB and LVDS, because PLP3216S does not provide distortion to high speed signal transmission due to its high coupling (Coupling coefficient:0.98 min.)

## APPLICATIONS

- Common mode noise suppression of signal lines in high speed and high density digital equipment such as personal computers and peripherals.

## PART NUMBERING

(Please specify the part number when ordering.)

(Ex.) 

<b>PLP3216S</b>	<b>551</b>	<b>SL</b>	<b>2</b>	<b>T1</b>
①	②	③	④	⑤

- ① Type
- ② Typical Impedance at 100MHz
- ③ Other Characteristics
- ④ Number of Line
- ⑤ Packaging Code    T1 : Taped  
                              B1 : Bulk package

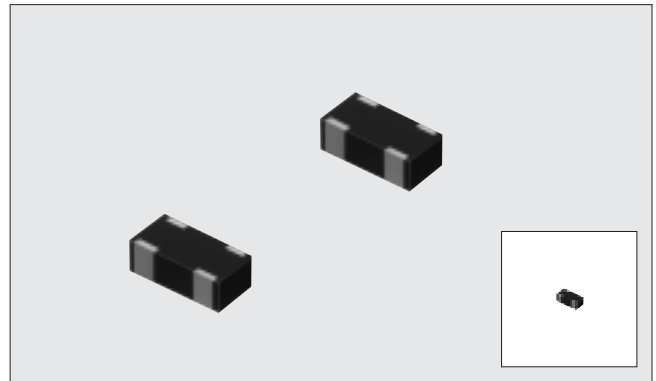

## DIMENSIONS

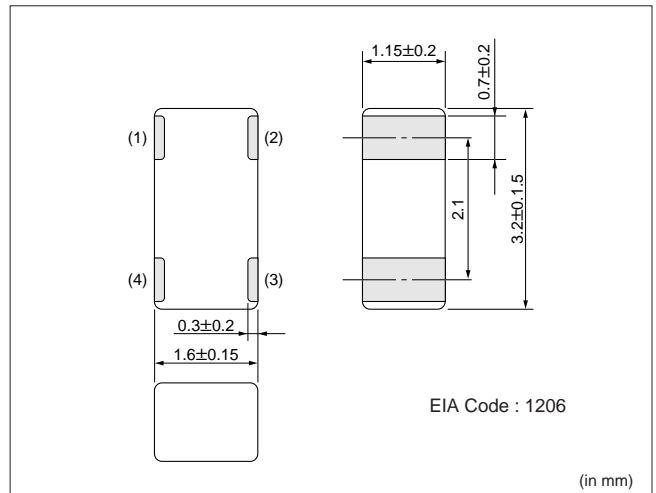

## EQUIVALENT CIRCUIT DIAGRAM

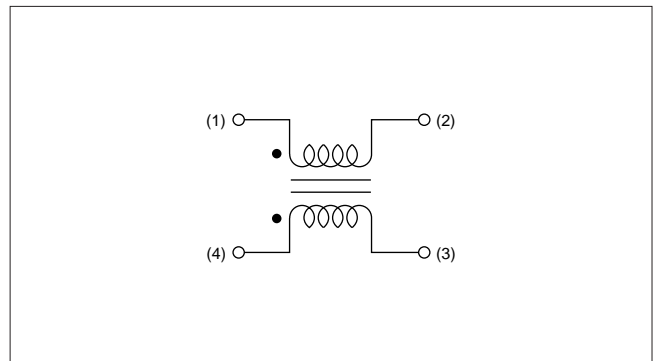

2

■SPECIFICATIONS

Part Number	Rated Current (A)	Common mode Impedance ( $\Omega$ ) (Typ.) at 100MHz	DC Resistance ( $\Omega$ ) max.	Rated Voltage (Vdc)	Withstand Voltage (Vdc)	Insulation Resistance ( $\Omega$ ) min.	Operating Temp. Range ( $^{\circ}$ C)
PLP3216S121SL2	0.1	120	2.0	16	40	100M	-40 to +85
PLP3216S221SL2		220	2.5				
PLP3216S551SL2		550	3.6				

■IMPEDANCE-FREQUENCY CHARACTERISTICS (TYPICAL)

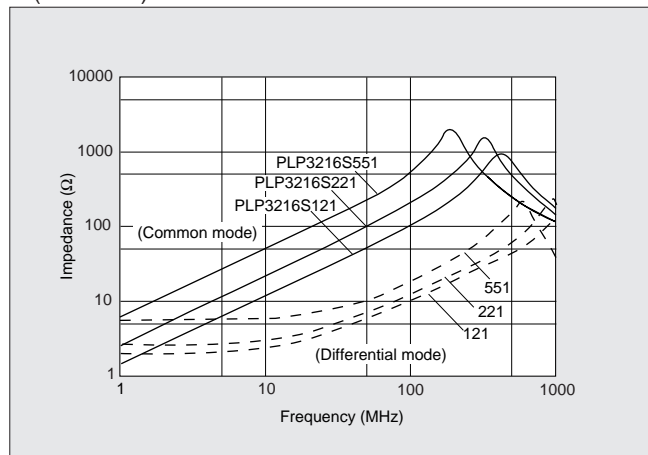

2

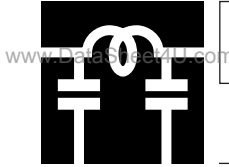

**CHIP EMIFIL®**

EMIFIL® is the trademark of Murata Manufacturing Co., Ltd.



Multilayer Type Chip Common Mode Choke Coil **PLM3216K**

# For Common Mode Noise Suppression in High Speed Signal Lines SMD, Ultra Small Size Common Mode Choke Coil

The PLM3216K series is effective in high frequency noise suppression and suitable for suppression of radiation noise in signal cables. The common mode choke coil structure enables noise suppression without damaging the signal. Murata's original material technology and monolithic technology enable a compact size of 3.2×1.6×1.15mm.

**FEATURES**

1. The PLM3216K series is effective for common mode noise suppression in digital equipment which causes radiation from cables.
2. Low leakage flux due to monolithic structure enables high density mounting.
3. The nickel barrier structure of the external electrodes provides excellent solder heat resistance.

**APPLICATIONS**

- Prevention of common mode noise on signal line in personal computers, computer built in equipments, facsimiles, digital telephones, etc.

**PART NUMBERING**

(Please specify the part number when ordering.)



- ① Type
- ② Typical Impedance at 100MHz  
281 : 280Ω
- ③ Other Characteristics
- ④ Number of Line
- ⑤ Packaging Code    T1 : Taped  
                              B1 : Bulk package

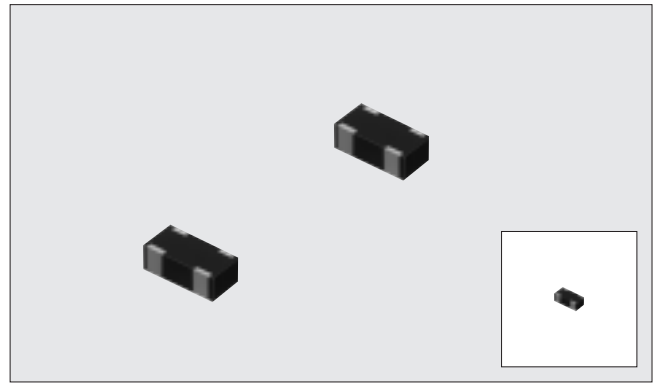

**DIMENSIONS**

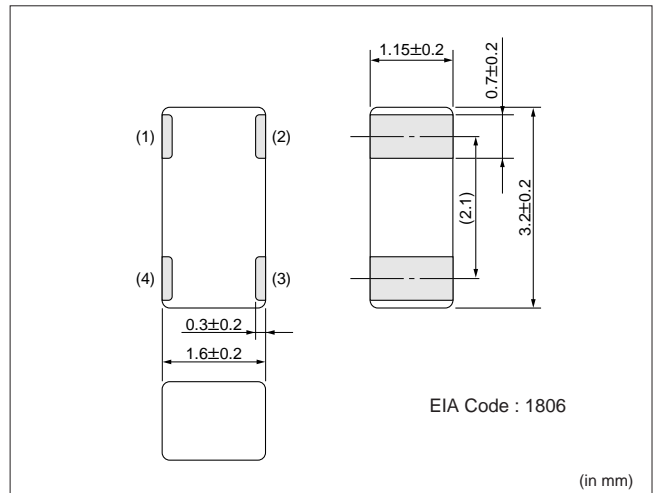

**EQUIVALENT CIRCUIT DIAGRAM**

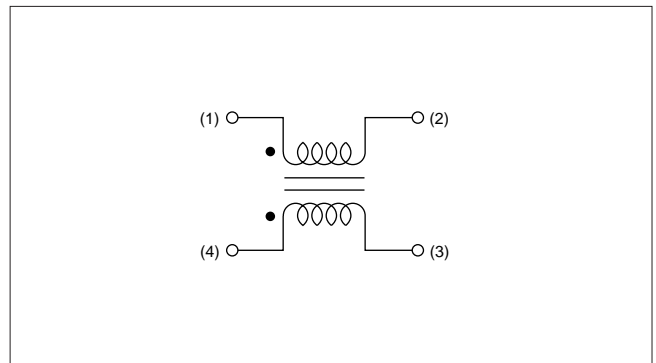

**■SPECIFICATIONS**

www.DataSheet4U.com  
Part Number

Part Number	Rated Current (mA)	Common mode Impedance ( $\Omega$ ) (Typ.) at 100MHz	DC Resistance ( $\Omega$ ) max.	Withstand Voltage (Vdc)	Rated Voltage (Vdc)	Insulation Resistance ( $\Omega$ ) min.	Operating Temp. Range ( $^{\circ}$ C)
PLM3216K281SJ2	200	280	2.0	125	50	100M	-55 to +85

**■IMPEDANCE-FREQUENCY CHARACTERISTICS (TYPICAL)**

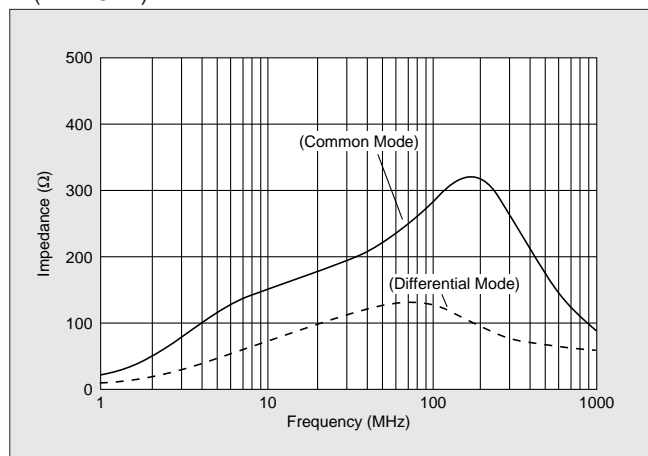

2



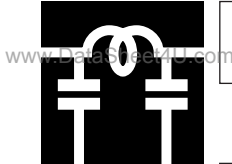

CHIP EMIFIL®

EMIFIL® is the trademark of Murata Manufacturing Co., Ltd.



Wire Wound Type Chip Common Mode Choke Coil **PLW3216S** Series

# Wire Wound Type Chip Common Mode Choke Coil with High Impedance and High Coupling Suitable for IEEE1394 and LVDS

## FEATURES

1. PLW3216S realizes small size and low profile.  
3.2mm×1.6mm×1.9mm.
2. High common mode impedance at high frequency effects excellent noise suppression performance.
3. Various common mode impedance items of 90 to 2200Ω can be used, considering noise level and signal frequency.
4. Suitable for differential signal line like IEEE1394 and LVDS, because PLW3216S dose not provide distortion to high speed signal transmission due to its high coupling.
5. PLW3216S is lead free design.
6. Small dimension enables higher density packaging.

## APPLICATIONS

- Common mode noise suppression of signal lines in high speed and high density digital equipment such as personal computers and peripherals.

## PART NUMBERING

(Please specify the part number when ordering.)

(Ex.) **PLW3216S** **900** **SQ** **2** **T1**

①            ②            ③            ④            ⑤

- ① Type
- ② Typical Impedance at 100MHz  
900 : 90Ω
- ③ Other Characteristics
- ④ Number of Line
- ⑤ Packaging Code    T1 : Taped  
                                  B1 : Bulk package

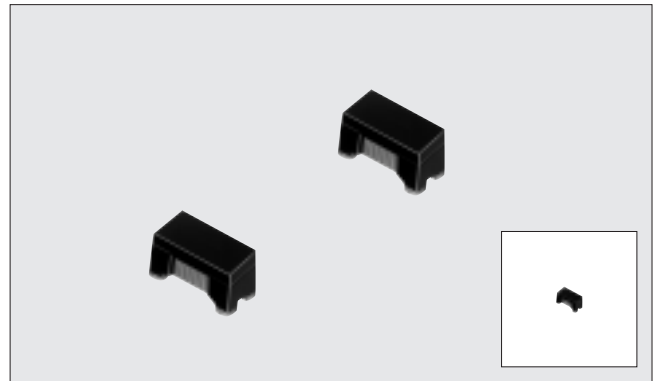

## DIMENSIONS

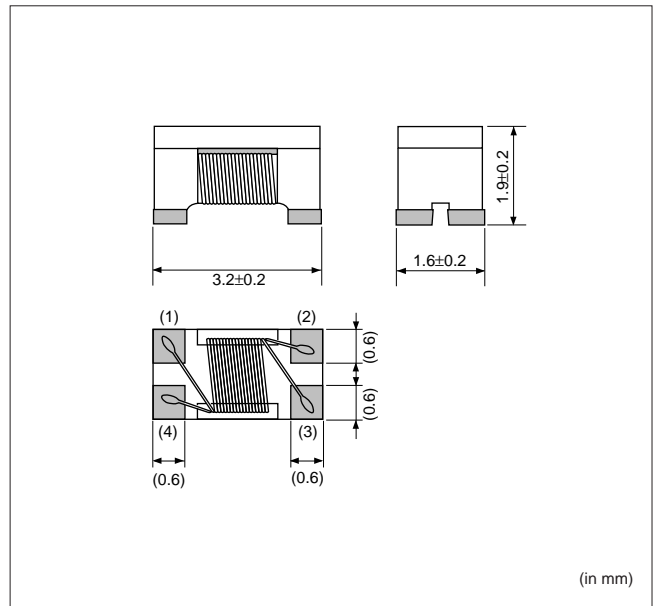

## EQUIVALENT CIRCUIT DIAGRAM

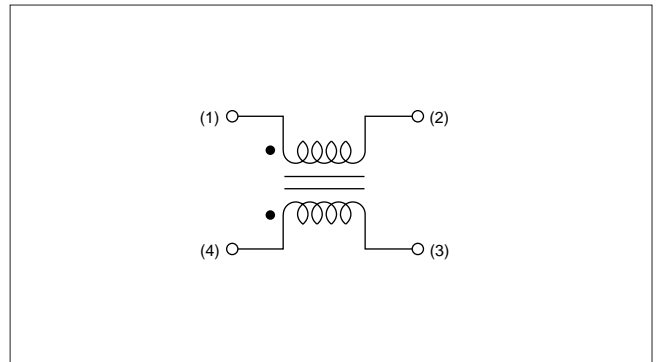

**■SPECIFICATIONS**

Part Number	Rated Current (mA)	Common mode Impedance ( $\Omega$ ) (Typ.) at 100MHz	DC Resistance ( $\Omega$ ) max.	Withstand Voltage (Vdc)	Rated Voltage (Vdc)	Insulation Resistance ( $\Omega$ ) min.	Operating Temp. Range ( $^{\circ}$ C)
PLW3216S900SQ2	370	90	0.3	125	50	10M	-40 to +85
PLW3216S161SQ2	340	160	0.4				
PLW3216S261SQ2	310	260	0.5				
PLW3216S601SQ2	260	600	0.8				
PLW3216S102SQ2	230	1000	1.0				
PLW3216S222SQ2	200	2200	1.2				

**■IMPEDANCE-FREQUENCY CHARACTERISTICS (TYPICAL)**

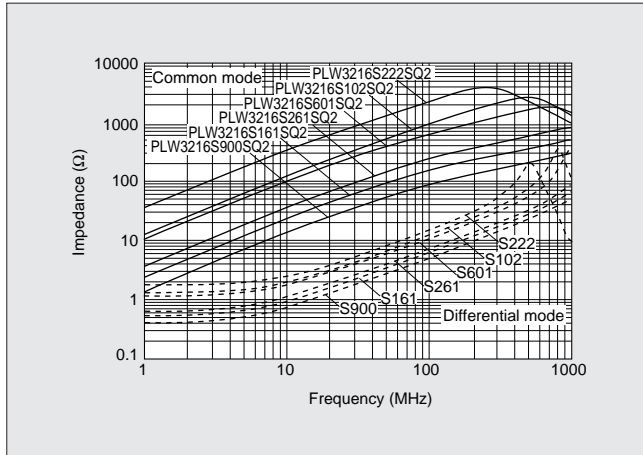

2

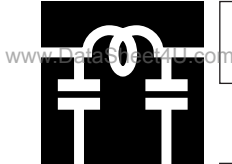

CHIP EMIFIL®

EMIFIL® is the trademark of Murata Manufacturing Co., Ltd.



Chip Common Mode Choke Coil **PLM250H/250S** Series

# Wire Wound Chip Type with High Impedance, Large Current, High Coupling Are Condensed into Small Chip

## FEATURES

1. High impedance (maximum of 4kΩ at 100MHz : PLM250H10) enables great noise suppression.
2. Large rated current (maximum of 2A) enables power line use.
3. The PLM250 series dose not damage high speed signal due to high coupling common mode choke coil structure.
4. Automatic mounting can be applied.
5. The PLM250 series is specially adapted for reflow soldering.

## APPLICATIONS

- Common mode noise suppression of signal lines in high speed digital equipment such as HDTVs, computers and peripherals
- Common mode noise suppression of DC power lines in AC adapter of notebook size computers, game machines and digital audio equipments

## PART NUMBERING

(Please specify the part number when ordering.)



① Type

② Class No.

③ Packaging Code    T1 : Taped (φ 180mm reel)  
                                  T2 : Taped (φ 330mm reel)  
                                  B1 : Bulk Package

## EQUIVALENT CIRCUIT DIAGRAM

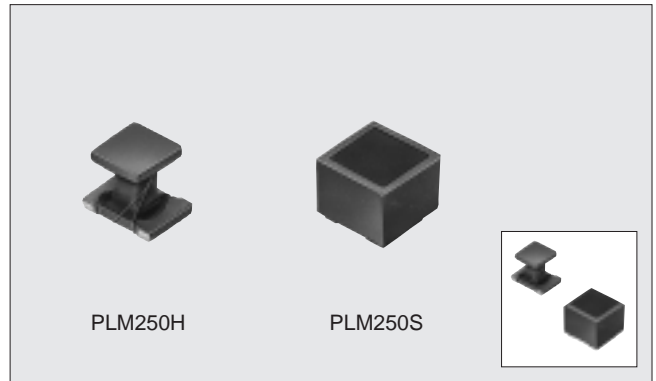
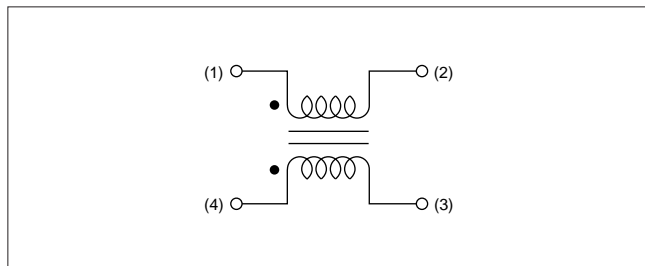

## DIMENSIONS

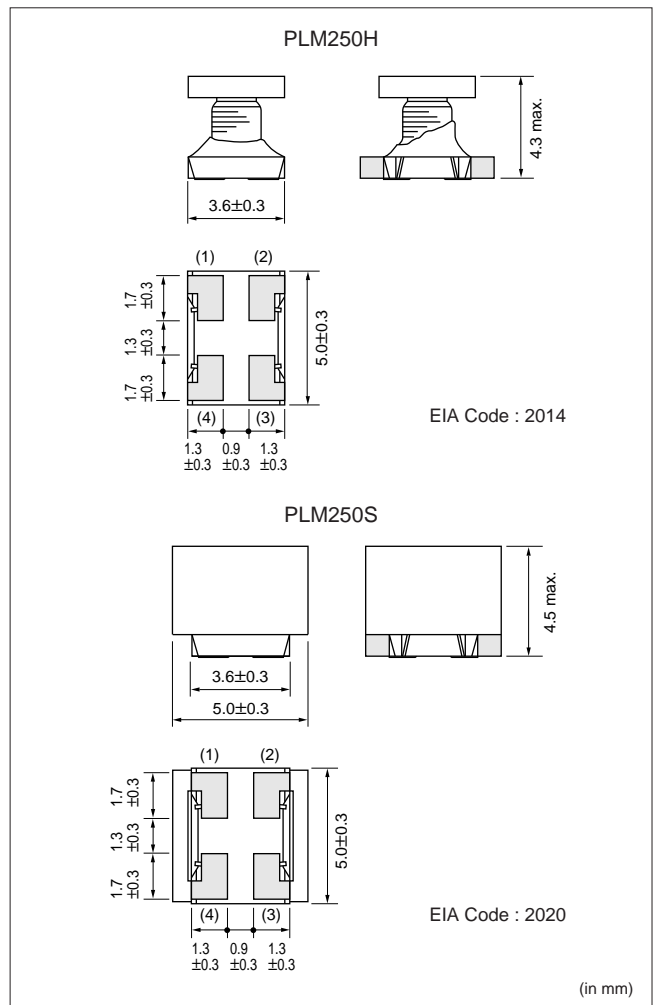

**■ SPECIFICATIONS**

Part Number	Rated Current (A)	Impedance (Ω) (Typ.) at 100MHz	DC Resistance (Ω) max.	Rated Voltage (Vdc)	Withstand Voltage (Vdc)	Insulation Resistance (MΩ) min.	Operating Temp. Range (°C)
PLM250H10	0.2	4000	3.0	50	125	10	-25 to +85
PLM250S20	0.5	3000	0.3				
PLM250S30	1.0	1500	0.1				
PLM250S40	1.5	1000	0.06				
PLM250S50	2.0	350	0.04				
PLM250S60	5.0*	190	0.02				

\*When the PLM250S60 used in operating temperatures exceeding +75°C, derating of current is necessary. Please apply the derating curve shown above according to the operating temperature.

**■ IMPEDANCE-FREQUENCY CHARACTERISTICS (TYPICAL)**

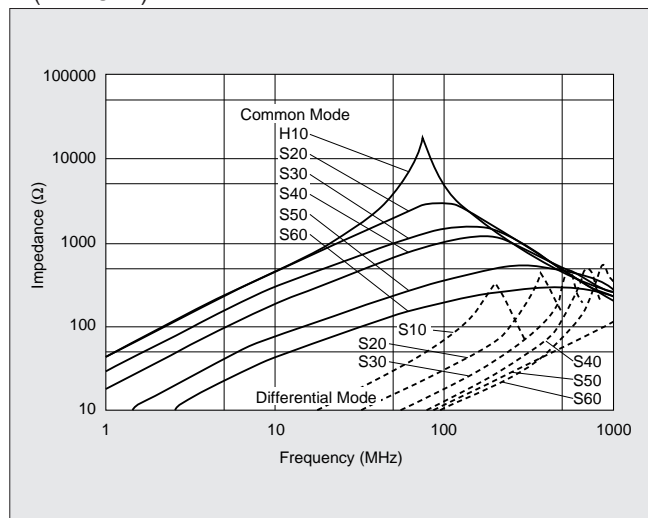

**■ DERATING (PLM250S60)**

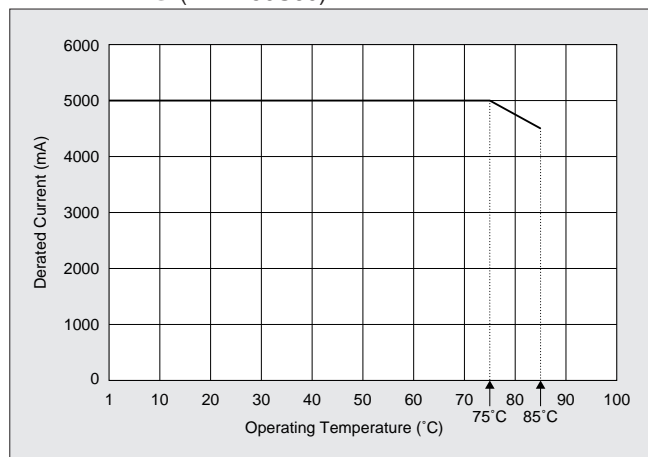



**■ SPECIFICATIONS**

Part Number	Rated Voltage (Vdc)	Varistor Voltage V1mA (V)	Clamping Voltage (V max.)	Peak Pulse Current 8/20μs (A)	Energy Rating (J)	ESD Test (150pF, 330Ω)	Capacitance 1MHz (pF)	Operating Temp. Range (°C)
VCM11R5R6A400	5.6	9±2	15.5 (V1A)	40	0.05	8kV, 10 times	700±30%	-40 to +125
VCM11R180A300	18	29±5	50 (V1A)	30				
VCM21R180A151		25±5	45 (V10A)	150	0.3	30kV, 10 times	1000±30%	

**■ VOLTAGE-CURRENT CHARACTERISTICS (TYPICAL)**

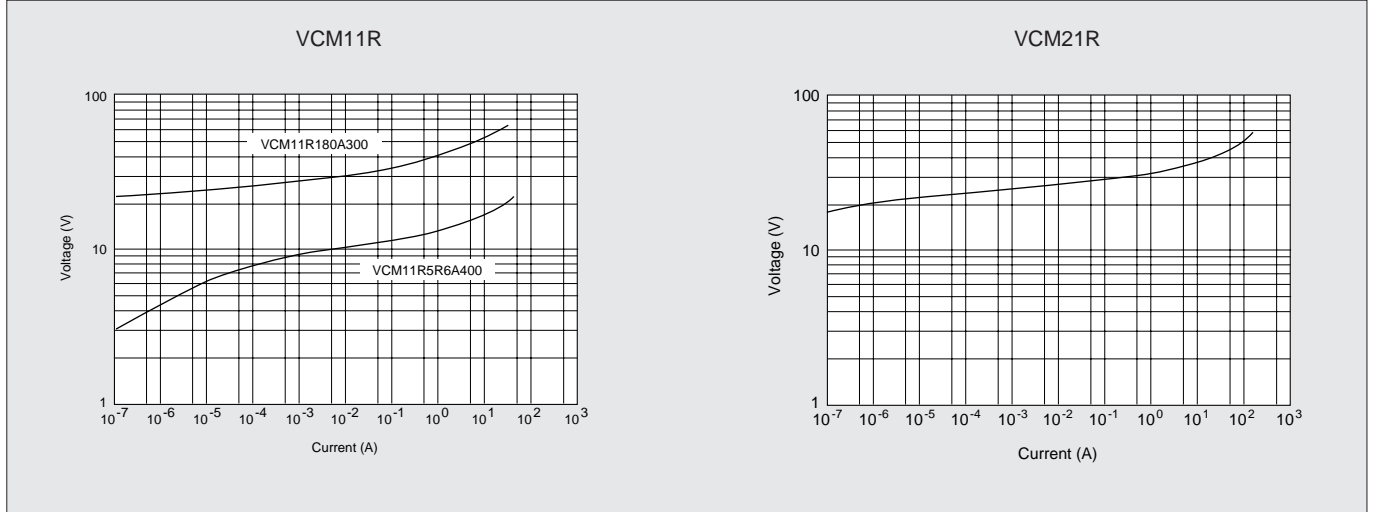

2

Notice of Chip EMIFIL®/Chip Varistor

www.DataSheet4U.com

CAUTION

1. Rated Current/Rated Voltage/Operating Temperature

- Don't use products beyond the rated current, the rated voltage and the operating temperature range, or, a fire may result due to the deterioration of the insulation resistance, excessive heat, etc.

2. Mounting Density

- Give special attention when mounting products close to other product that radiate heat. The excessive heat by other products may cause deterioration of insulation resistance and excessive heat at this product, resulting in the fire.

NOTICE

1. Standard Land Pattern Dimensions

The capacitor type chip EMI suppression filters (NFM/NFA series) suppress noise by conducting the high-frequency noise element to ground. Therefore, to obtain maximum performance from these filters, the ground pattern should be made as large as possible during the PCB design stage. As shown below, one side of the PCB is used for chip mounting, and the other is used for grounding. Small diameter feedthrough holes are then used to connect the grounds on each side of the PCB. This reduces the high-frequency impedance of the grounding and maximizes the filter's performance.

Copper Foil Pattern Resist (in mm)

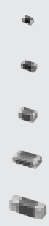

**BLM10/11/21/31/41** • Reflow and Flow for Mounting Alone

**BLM Series**  
(Except 21P, 31P, 41P)

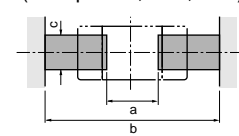

Type	Size(mm)				
	L	W	a	b	c
*BLM10 (Reflow)	1.0	0.5	0.4	1.2-1.4	0.5
BLM11 (Flow)	1.6	0.8	0.7	2.2-2.6	0.7
BLM11 (Reflow)	1.6	0.8	0.7	1.8-2.0	0.7
BLM21	2.0	1.25	1.2	3.0-4.0	1.0
BLM31	3.2	1.6	2.0	4.2-5.2	1.2
BLM41	4.5	1.6	3.0	5.5-6.5	1.2

\*BLM10 is specially adapted for reflow soldering

- Don't apply narrower pattern than listed above to BLM□□P. Narrow pattern can cause excessive heat or open circuit.

**BLM21P/31P/41P**

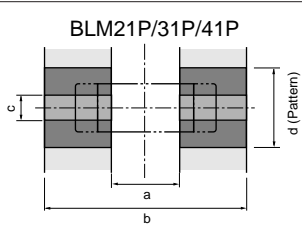

Type	Rated Current (A)	Size(mm)			Land pad thickness and Dimension d		
		a	b	c	18μm	35μm	70μm
					d		
BLM21P331SG	1.5	1.2	3.0-4.0	1.0	1.0	1.0	1.00
BLM21P221SG	2				1.2	1.0	1.00
BLM21P300S/BLM21P600SG	3				2.4	1.2	1.00
BLM21P220SG	6	2.0	4.2-5.2	1.2	6.4	3.3	1.65
BLM31P330SG	6				2.4	1.2	1.20
BLM31P500S/BLM31P121SG	3				2.4	1.2	1.20
BLM31P391SG	2	3.0	5.5-6.5	1.2	1.2	1.2	1.20
BLM31P601SG	1.5				1.2	1.2	1.20
BLM41P800S	1				1.2	1.2	1.20
BLM41P102SG	1.5	3.0	5.5-6.5	1.2	2.4	1.2	1.20
BLM41P471SG	2				2.4	1.2	1.20
BLM41P750S/BLM41P181SG	3				2.4	1.2	1.20
BLM41P600S	6	6.4	3.3	1.65			

\*Please contact us if using thinner land pad than 18μm.

• Flow Mounting in High Density

**BLM31/41**

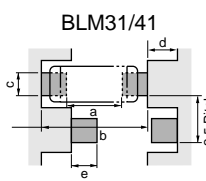

Type	Type				
	a	b	c	d	e
BLM31	2.0	4.2 to 5.2	1.2	1.3	1.35
BLM41	3.0	5.5 to 6.5	1.2	1.8	1.5

**BLA3216** • Reflow and Flow

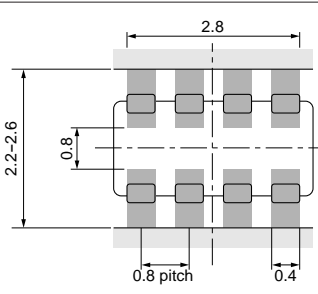

- The excessive heat by land pads may cause deterioration at joint products with substrate.



# Notice of Chip EMIFIL®/Chip Varistor

www.DataSheet4U.com

■ Copper Foil Pattern □ Resist (in mm)

NFM2012R/40R/  
3212R/41R/4516R  
NFM2012P/40P/  
4516P  
NFM839R  
VFM41R

● Reflow and Soldering

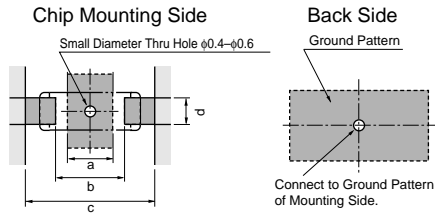

Typ	Dimensions (mm)			
	a	b	c	d
NFM2012R/839R NFM2012P	0.8	1.4	2.6	0.6
NFM40R/ 3212R/40P	1.4	2.5	4.4	1.0
NFM41R/4516R/4516P VFM41R	2.0	3.5	6.0	1.2

•NFM2012R/839R/2012P is specially adapted for reflow soldering.

● Flow and Soldering

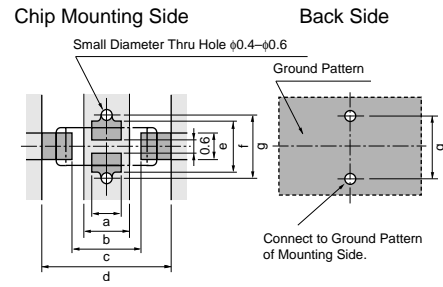

Typ	Dimensions (mm)						
	a	b	c	d	e	f	g
NFM40R/ 3212R/40P	1.0	1.4	2.5	4.4	1.0	2.0	2.4
NFM41R/4516R/4516P VFM41R	1.5	2.0	3.5	6.0	1.2	2.6	3.0

NFA3216G  
NFA3216D  
NFA62R  
NFA81R

● Reflow Soldering

NFA3216G/NFA3216D

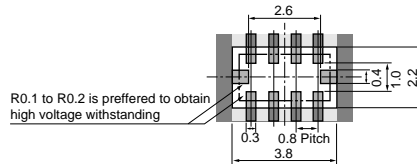

•NFM3216G/NFA3216D is specially adapted for reflow soldering.

● Reflow and Flow

NFA62R

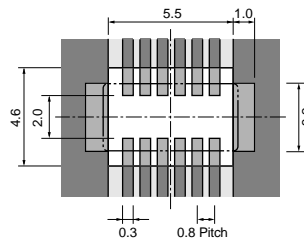

NFA81R

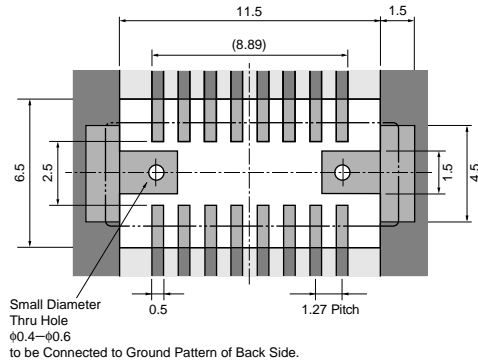

NFM51R  
NFM60R

● Reflow and Flow  
NFM51R

Chip Mounting Side

Back Side

● Reflow Soldering  
NFM60R

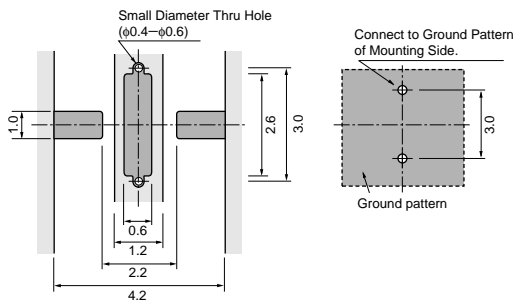





•NFM60R is specially adapted for reflow soldering.

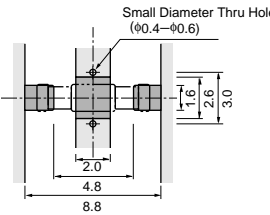
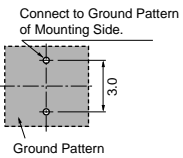
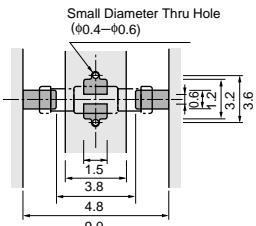
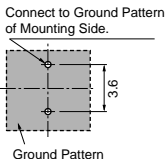

Notice of Chip EMIFIL®/Chip Varistor

www.DataSheet4U.com

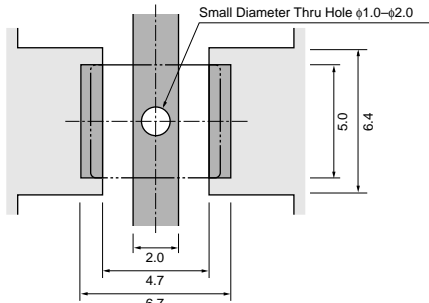
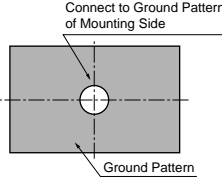
■ Copper Foil Pattern □ Resist (in mm)

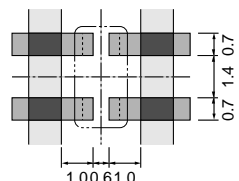
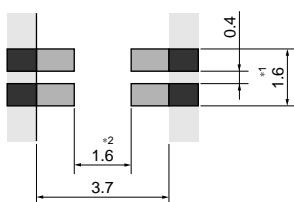
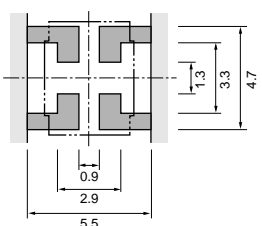
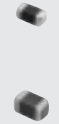
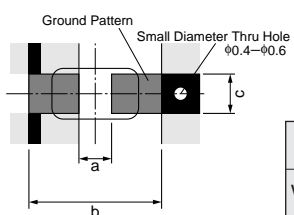
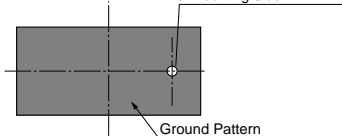
<p>NFM61R NFM61RH</p> 	<p>● Reflow Soldering</p> <p>Chip Mounting Side</p>  <p>Back Side</p> 	<p>● Flow Soldering</p> <p>Chip Mounting Side</p>  <p>Back Side</p> 																						
<p>NFM46P</p> 	<p>● Reflow Soldering</p> <p>Chip Mounting Side</p>  <p>Back Side</p> <p>Ground on back side should be designed to be as large as possible.</p>  <ul style="list-style-type: none"> <li>• NFM46P is specially adapted for reflow soldering.</li> <li>• Please contact us if using thinner land pad than 18μm.</li> </ul>																							
<p>PLP3216S PLM3216K PLW3216S PLM250</p> 	<p>● Reflow and Flow</p> <p>PLP3216S PLM3216K</p> 	<p>● Reflow Soldering</p> <p>PLW3216S</p>  <p>PLM250</p>  <p>*1 : If the pattern is made with wider than 1.6mm, it will result to let components turn around, because melting speed is different. In the worst case, short circuit between lines may be occurred.</p> <p>*2 : If the pattern is made with wider than 1.6mm, the strength of bending will be reduced.</p> <ul style="list-style-type: none"> <li>• PLW3216S/PLM250 is specially adapted for reflow soldering.</li> </ul>																						
<p>VCM11R VCM21R</p> 	<p>● Reflow and Flow</p> <p>Chip Mounting Side</p>  <table border="1" data-bbox="614 1870 1013 2004"> <thead> <tr> <th rowspan="2">Type</th> <th rowspan="2"></th> <th colspan="3">Size (mm)</th> </tr> <tr> <th>a</th> <th>b</th> <th>c</th> </tr> </thead> <tbody> <tr> <td rowspan="2">VCM11R</td> <td>Flow</td> <td>0.7</td> <td>2.2-2.6</td> <td>0.7</td> </tr> <tr> <td>Reflow</td> <td>0.7</td> <td>1.8-2.0</td> <td>0.7</td> </tr> <tr> <td>VCM21R</td> <td></td> <td>1.2</td> <td>3.0-4.0</td> <td>1.0</td> </tr> </tbody> </table> <p>Back Side</p> <p>Ground on back side should be designed to be as large as possible.</p> 		Type		Size (mm)			a	b	c	VCM11R	Flow	0.7	2.2-2.6	0.7	Reflow	0.7	1.8-2.0	0.7	VCM21R		1.2	3.0-4.0	1.0
Type		Size (mm)																						
		a	b	c																				
VCM11R	Flow	0.7	2.2-2.6	0.7																				
	Reflow	0.7	1.8-2.0	0.7																				
VCM21R		1.2	3.0-4.0	1.0																				

2

**Notice of Chip EMIFIL®/Chip Varistor**

www.DataSheet4U.com

**2. Solder Paste Printing and Adhesive Application**

When reflow soldering the chip EMI suppression filter./Chip varistor, the printing must be conducted in accordance with the following cream solder printing conditions.

If too much solder is applied, the chip will prone to be damaged by mechanical and thermal stress from the PCB and may crack.

In contrast, if too little solder is applied, there is the potential that the termination strength will be insufficient, creating the potential for detachment.







Standard land dimensions should be used for resist and copper foil patterns.

When flow soldering the EMI suppression filter/Chip Varistor, apply the adhesive in accordance with the following conditions.

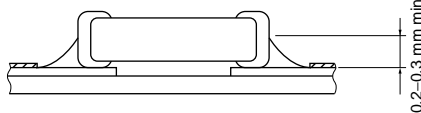
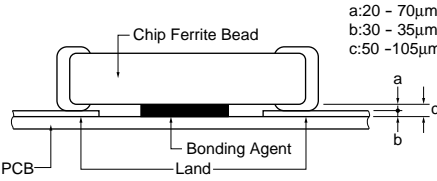
If too much adhesive is applied, then it may overflow into the land or termination areas and yield poor solderability.

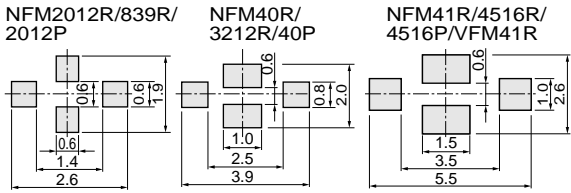
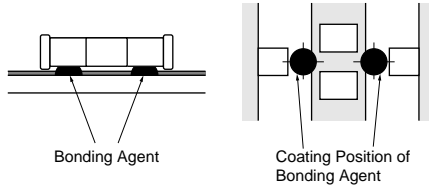
In contrast, if insufficient adhesive is applied, or if the adhesive is not sufficiently hardened, then the chip may become detached during flow soldering.

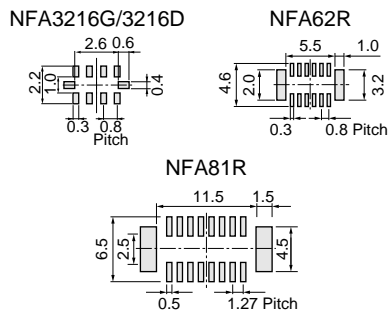
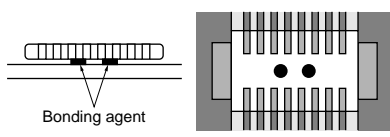

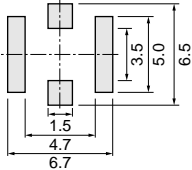
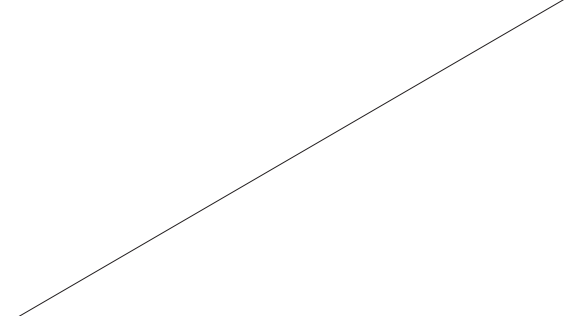



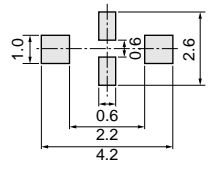
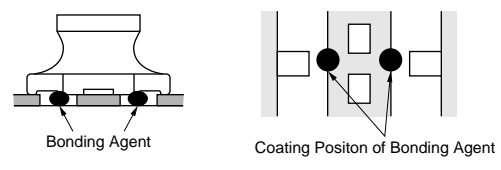

(in mm)

Series	Solder Paste Printing	Adhesive Application
<p>BLM10/11/21/31/41 BLA3216 VCM11R/21R</p> 	<ul style="list-style-type: none"> <li>Ensure that solder is applied smoothly to a minimum height of 0.2mm to 0.3mm at the end surface of the part.</li> <li>Coat the solder paste a thickness of 100µm to 200µm.</li> </ul> 	<ul style="list-style-type: none"> <li>Coating amount is illustrated in the following diagram.</li> </ul> 
<p>NFM2012R/40R/ 3212R/41R/4516R NFM2012P/40P/ 4516P NFM839R VFM41R</p> 	<ul style="list-style-type: none"> <li>Coat the solder paste a thickness of 100µm to 150µm (NFM2012P/2012R/40R/3212R/40P/839R), and 100µm to 200µm (NFM41R/4516R/4516P, VFM41R).</li> <li>Use H60A solder for pattern printing.</li> </ul> 	<ul style="list-style-type: none"> <li>Apply 0.1mg for NFM41R/4516R/4516P, VFM41R and 0.06mg for NFM40R/3212R/40P of bonding agent at each chip.</li> </ul> 
<p>NFA62R/81R NFA3216G NFA3216D</p> 	<ul style="list-style-type: none"> <li>Coat the solder paste a thickness of 100µm (NFA3216G/3216D) and 150µm (NFA62R) and 200µm (NFA81R).</li> <li>Use H60A solder for pattern printing.</li> </ul> 	<ul style="list-style-type: none"> <li>Apply 0.5mg to 0.9mg for NFA81R and 0.25mg to 0.6mg for NFA62R of bonding agent at each chip, and ensure not to cover electrodes.</li> </ul> 
<p>NFM46P</p> 	<ul style="list-style-type: none"> <li>Coat the solder paste a thickness of 200µm.</li> <li>Use H60A solder for pattern printing.</li> </ul> 	

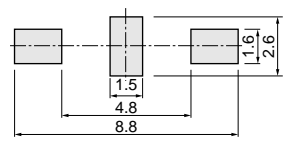
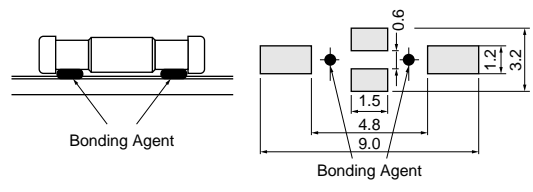
Notice of Chip EMIFIL®/Chip Varistor

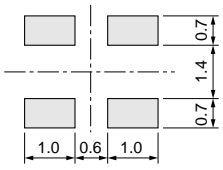
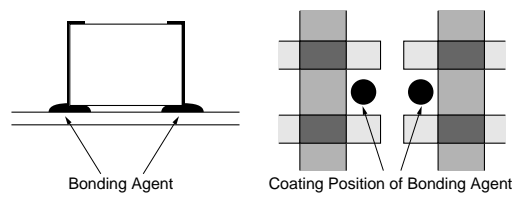
www.DataSheet4U.com

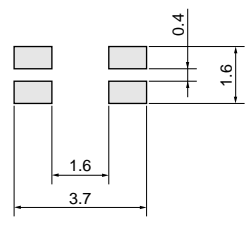
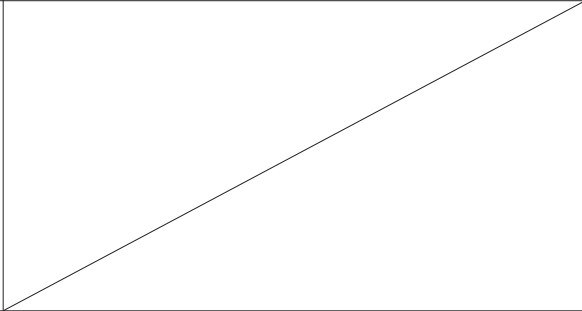
(in mm)

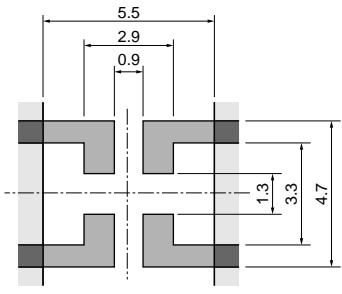
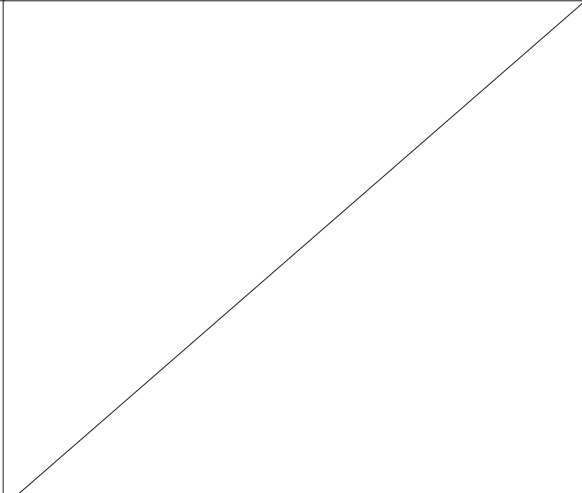
Series	Solder Paste Printing	Adhesive Application
<p>NFM51R NFM60R</p> 	<ul style="list-style-type: none"> <li>Coat the solder paste a thickness of 200µm (NFM51R) and 150µm (NFM60R).</li> <li>Use H60A solder for pattern printing.</li> </ul> 	<ul style="list-style-type: none"> <li>Apply 0.2mg of bonding agent at each chip.</li> </ul> 
<p>NFM61R/61RH</p> 	<ul style="list-style-type: none"> <li>Coat the solder paste a thickness of 200µm.</li> <li>Use H60A solder for pattern printing.</li> </ul> 	<ul style="list-style-type: none"> <li>Apply 1.0mg of bonding agent at each chip.</li> </ul> 
<p>PLP3216S PLM3216K</p> 	<ul style="list-style-type: none"> <li>Coat the solder paste a thickness of 150µm.</li> <li>Use H60A solder for pattern printing.</li> </ul> 	<ul style="list-style-type: none"> <li>Apply 0.3mg of bonding agent at each chip.</li> </ul> 
<p>PLW3216S</p> 	<ul style="list-style-type: none"> <li>Coat the solder paste a thickness of 100µm.</li> <li>Use H60A solder for pattern printing.</li> </ul> 	
<p>PLM250</p> 	<ul style="list-style-type: none"> <li>Coat the solder paste a thickness of 200µm.</li> <li>Use H60A solder for pattern printing.</li> </ul> 	

2

**Notice of Chip EMIFIL®/Chip Varistor**

www.DataSheet4U.com

**3. Standard Soldering Conditions**

**(1) Soldering Methods**

Use flow and reflow soldering methods only.  
 Use standard soldering conditions when soldering chip EMI suppression filters, Chip Varistor.  
 In cases where several different parts are soldered, each having different soldering conditions, use those conditions requiring the least heat and minimum time.

**(2) Soldering Temperature and Time**

To prevent external electrode solder leaching and performance deterioration, solder within the temperature and time combinations illustrated by the slanted lines in the following graphs. If soldering is repeated, please note that the allowed time is the accumulated time.

• Allowable Flow Soldering Temperature and Time

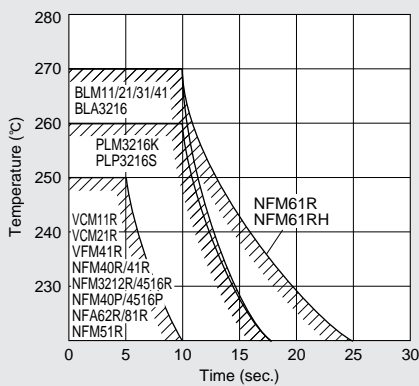

• Allowable Reflow Soldering Temperature and Time

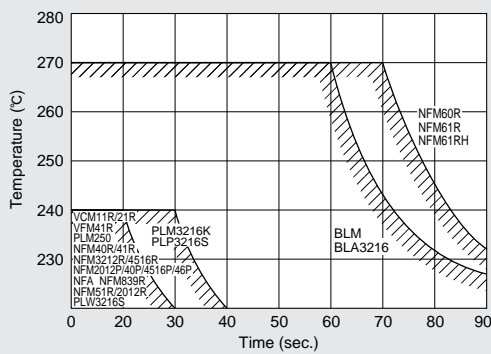

**(3) Solder and Flux**

- Solder : H60A H63A solder (JIS Z3282)
- Flux : Use Rosin-based flux (when using RA type solder, clean products sufficiently to avoid residual flux.
- : Do not use strong acidic flux (with chlorine content exceeding 0.20wt%).
- : Do not use water-soluble flux.

**(4) Reworking with Soldering Iron**

The following conditions must be strictly followed when using a soldering iron.  
 Preheating : 150°C, 1 minute  
 Soldering iron : 30W max.  
 Tip Temperature : 280°C max.  
 Soldering Time : 10 second max.  
 Do not allow the tip of the soldering iron to contact the chip directly.  
 For additional methods of reworking with soldering iron. Please contact Murata engineering.

**(5) Soldering Conditions**

• Flow Solder (Wave Solder)

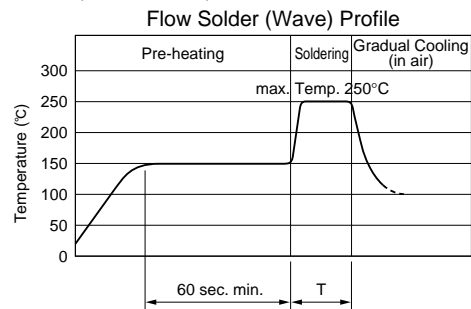

Series	Pre-heating (150°C)	Soldering Tim (T)	Soldering Temp. (°C)
BLM, BLA3216	60sec. min.	10sec. max.	250
NFA62R/81R			
NFM40R/41R			
NFM3212R/4516R			
NFM40P/4516P			
NFM51R			
NFM61R(H)			
VFM41R			
VCM11R/21R			
PLM3216K			
PLP3216S			

• Reflow Solder

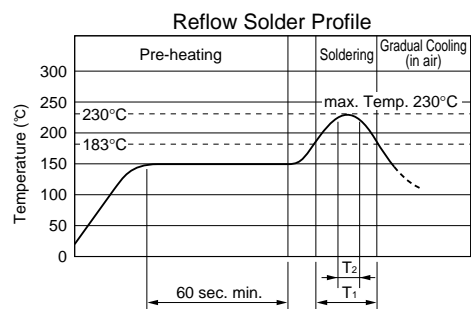

Series	Pre-heating (150°C)	Soldering Time	
		(T <sub>1</sub> )(183°C)	(T <sub>2</sub> )(230°C)
NFM61R(H)/60R	60sec. min.	60sec. max.	250°C, 20sec. max.
BLM, BLA3216			20sec. max.
NFA			
NFM2012R/40R/41R			
NFM3212R/4516R			
NFM40P/4516P/46P			
NFM51R			
VFM41R			
PLM3216K/250			
PLP3216S			
PLW3216S			
NFM839R			
VCM11R/21R			

#### 4. Cleaning

Following conditions should be observed when cleaning chip EMIFIL®.

- (1) Cleaning temperature : 60°C max. (40°C max. for CFC alternatives and alcohol cleaning agents)
- (2) Ultrasonic
  - Output : 20W/l max.
  - Duration : 5 minutes max.
  - Frequency : 28 to 40kHz
- (3) Cleaning agent
 

The following list of cleaning agents have been tasted on the individual components. Evaluation of final assembly should be completed prior to production.  
Do not clean PLM250, PLW3216S series.  
As for details of cleaning, please contact us.

  1. CFC alternatives and alcohol cleaning agents
    - Isopropyl alcohol (IPA)
    - HCFC-225
  2. Aqueous cleaning agent
    - Surface active agent (Clean Thru 750H)
    - Hydrocarbon (Techno Cleaner 335)
    - High grade alcohol (Pine Alpha ST-100S)\*
    - \* VFM41R/VCM11R/21R series cannot be cleaned with high grade alcohol type aqueous cleaning agent.
    - Alkaline saponifier (Aqua Cleaner 240-cleaner should be diluted within 20% using deionized water.)
- (4) Ensure that flux residue is completely removed.  
Component should be thoroughly dried after aqueous agent has been removed with deionized water.
- (5) Some products may become slightly whitened. However, product performance or usage is not affected.  
For additional cleaning methods, please contact Murata engineering.

#### 5. Operating Environment

Do not use products in corrosive gas such as chlorine gas, acid or sulfide gas.

#### 6. Storage and Handling Requirements

- ① Storage Period
 

Products should be used within 12 months. Since after our inspection, which can be confirmed with inspection No. marked on the container.  
Solderability should be checked if its period is over.  
(NFM41P/46P, VCM series should be used within 6 months)
- ② Storage conditions
  - a) Storage temperature : -10 to +40°C  
Relative humidity : 30 to 70%  
Avoid sudden changes in temperature and humidity.
  - b) Do not store products in corrosive gas such as chlorine gas, acid or sulfide gas.

**Tape Dimensions of Chip EMIFIL®/Chip Varistor (EIA-JRC-1009B)**

www.DataSheet4U.com

**Missing components number**

The number of missing components are within 1piece or 0.1% of specified quantity per reel.

The missing components are not continued. The specified quantity per reef are kept.

BLM10/11/21/31, BLA3216, NFM2012R/839R/40R/3212R/40P/51R/60R, VCM11R/21R, PLP3216S, PLW3216S PLM3216K (8mm width paper/plastic tape)

\*BLM10 : 2.0±0.1

(There are holes in the cavities of the BLM21B222S/272S/BLM31 only. φ1.0 +0.3/-0)

Please contact us for BLM10/11 in bulk case.

Part Number	Cavity Size				Minimum Quantity (pcs/reel)		Type
	a	b	c	d	φ180mm	φ330mm	
BLM10	1.15	0.65	0.8		10,000	50,000	Paper
BLM11	1.85	1.05	1.1	-	4,000	10,000	
BLM21 (Except B222S/B272S)	2.25	1.45	1.1		4,000	10,000	
BLA3216	3.4	1.8	1.1	-	4,000	10,000	
NFA3216G/3216D	2.0	3.6	1.1	-	4,000	-	
NFM2012P	2.3	1.55	1.1	-	4,000	-	Plastic
BLM21 B222S/B272S	2.25	1.45	1.3	0.2	3,000	10,000	
BLM31 (A700S)	3.5	1.9	1.3 (1.75)	0.2	3,000 (2,500)	10,000 (8,000)	
NFM2012R/839R	2.3	1.55	0.7	0.25	4,000	-	
NFM40R/3212R/40P	3.4	1.4	0.85	0.2	4,000	-	
NFM51R/60R	3.6	1.9	2.0	0.2	2,000	-	
VCM11R	1.85	1.05	0.95	0.25	4,000	-	
VCM21R	2.25	1.45	1.3	0.3	3,000	-	
PLM3216K	3.5	1.9	1.3	0.25	3,000	-	
PLP3216S	3.6	2.0	2.1	0.3	2,000	-	

BLM41, NFM41R/4516R/4516P, NFM61R/61RH, VFM41R (12mm width plastic tape)

(There are holes in the cavities of the BLM41 only. φ1.5 +0.3/-0)

Part Number	Cavity Size			Minimum Quantity (pcs/reel)	
	a	b	c	φ180mm	φ330mm
BLM41	4.8	1.9	1.75	2,500	8,000
NFM41R/4516R/4516P	4.8	1.8	1.1	4,000	-
NFM61R/61RH	7.2	1.9	1.75	2,500	8,000
VFM41R	4.8	1.8	1.35	2,500	-

NFA62R, NFM46P, PLM250 (12mm width plastic tape)

(NFM46P : φ1.7±0.1)

Part Number	Cavity Size			Minimum Quantity (pcs/reel)	
	a	b	c	φ180mm	φ330mm
NFA62R	6.6	3.5	1.13	1,000	-
NFM46P	6.0	5.3	2.5	500	-
PLM250S (PLM250H)	5.5 (5.4)	5.4 (4.1)	4.7 (4.4)	400	1,500

NFA81R (24mm width plastic tape)

Minimum Quantity (order in sets only) : 1,000pcs./reel (φ 180mm)  
5,000pcs./reel (φ 330mm)

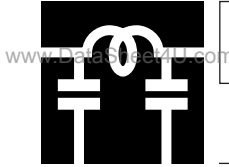

# EMI SUPPRESSION FILTERS

EMIFIL® is the trademark of Murata Manufacturing Co., Ltd.



## Ferrite Bead Inductor BL01/02/03 Series

BL01/02/03 series have put their lead through ferrite beads to produce a high frequency loss for suppression of noise. Simple construction and easy-to-use. Effective for low impedance circuits such as of power supply and ground. Effective also for overshoot of digital signal in clock or the like, preventing undershoot and suppressing of higher harmonic wave. Suitable for prevention of abnormal oscillation at high frequency amplifying circuit.

### ■PART NUMBERING

(Please specify the part number when ordering.)



- ① Bead Inductor
- ② Series Name (01 : Axial type, 02 : Radial type, 03 : Radial compact type)
- ③ Bead Characteristics, Quantity
- ④ Lead Configuration

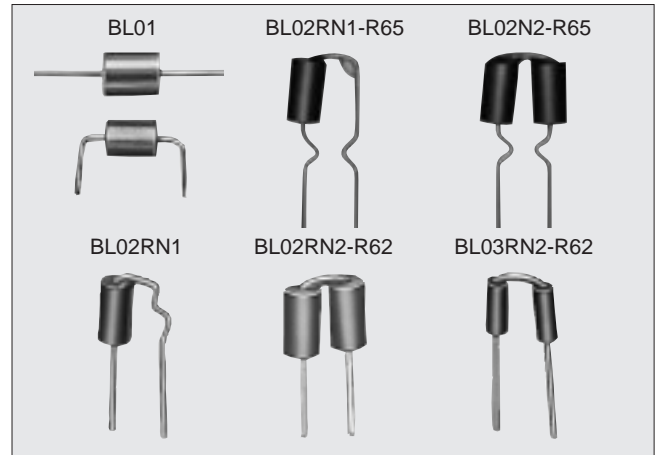

● Operating Temp. Rang -25 to 85°C

### ■DIMENSIONS (Please refer to pages 95 to 96 for taping specs.)

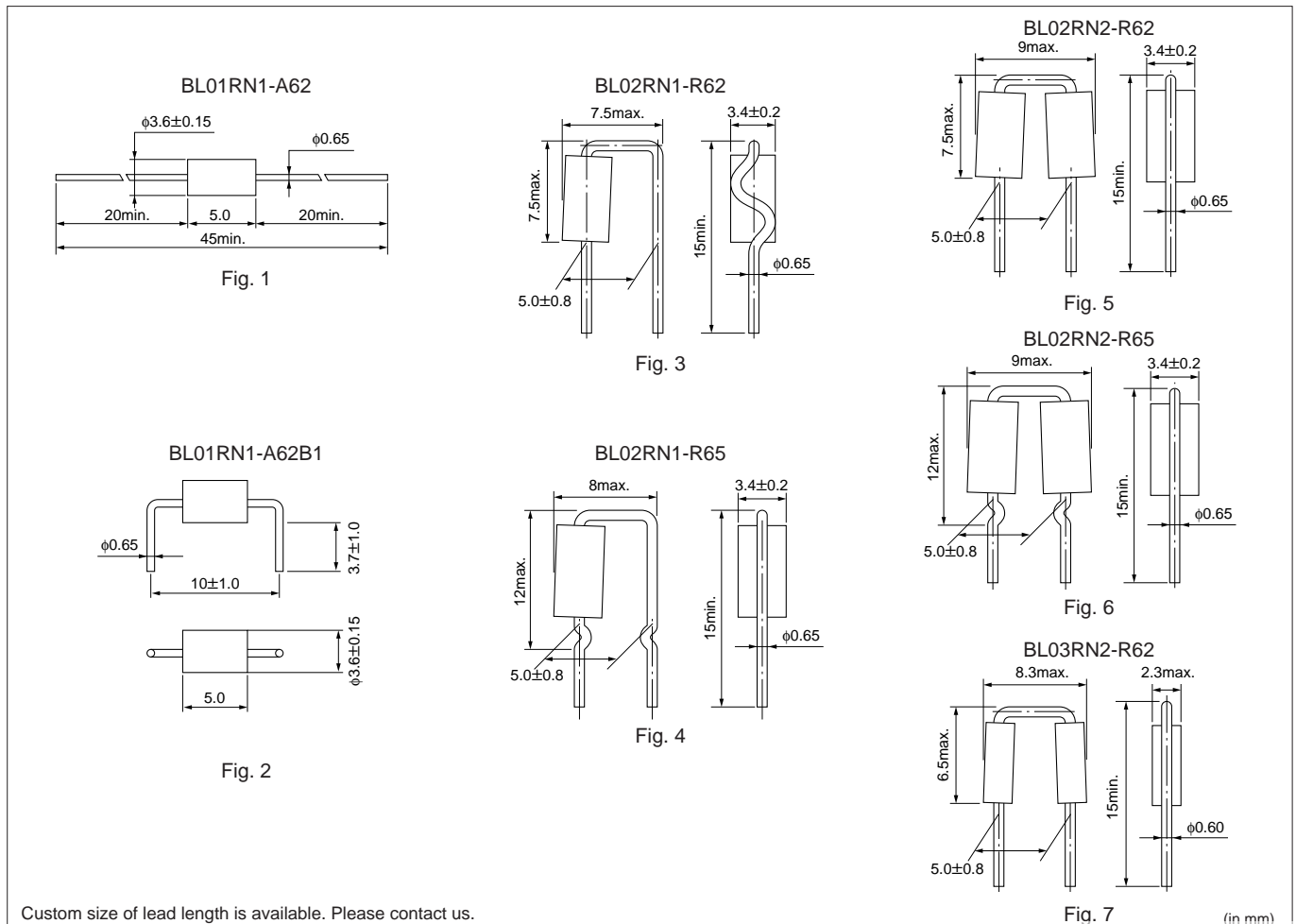

Custom size of lead length is available. Please contact us.



Axial Type BL01

www.DataSheet4U.com

■ FEATURES

1. Reduces on-board height because of axial lead.
2. PCB pattern can be designed underneath since the specific resistance of the material is great enough.



■ RATINGS (Please refer to pages 95 and 96 for taping specs.)

Part Number	Type	Rated Current	Dimensions
BL01RN1-A62	Straight	7A	Fig.1
BL01RN1-A62B1	Bent	7A	Fig.2

■ FREQUENCY CHARACTERISTICS

● BL01RN1

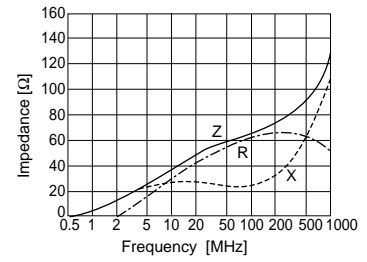

Radial Type BL02RN1



■ FEATURES

- Reduces mounting area because of radial lead.

■ RATINGS (Please refer to pages 95 and 96 for taping specs.)

Part Number	Type	Rated Current	Dimensions
BL02RN1-R62	Single-Crimp	7A	Fig.3
BL02RN1-R65	Double-Crimp	7A	Fig.4

■ FREQUENCY CHARACTERISTICS

● BL02RN1

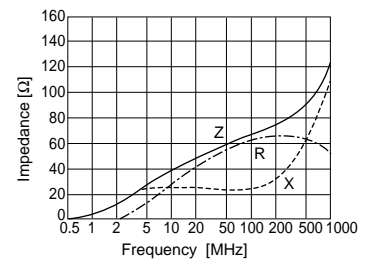

Radial Type BL02RN2



■ FEATURES

1. Reduces mounting area because of radial lead.
2. More effective noise suppression by using two beads.

■ RATINGS (Please refer to pages 95 and 96 for taping specs.)

Part Number	Type	Rated Current	Dimensions
BL02RN2-R62	Straight	7A	Fig.5
BL02RN2-R65	In-Crimp	7A	Fig.6

■ FREQUENCY CHARACTERISTICS

● BL02RN2

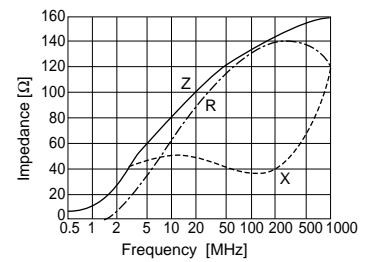

Compact Radial Type BL03



■ FEATURES

1. Can be mounted at 2.54 mm pitch.
2. Reduces mounting area because of radial lead.

■ RATINGS (Please refer to pages 95 and 96 for taping specs.)

Part Number	Rated Current	Dimensions
BL03RN2-R62	6A	Fig.7

■ FREQUENCY CHARACTERISTICS

● BL03RN2

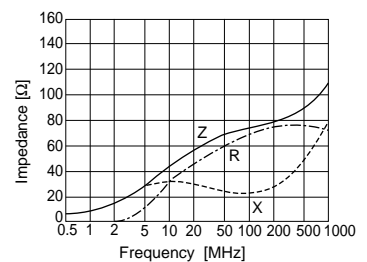



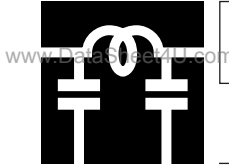

# EMI SUPPRESSION FILTERS

EMIFIL® is the trademark of Murata Manufacturing Co., Ltd.



## Disc-Type EMIFIL® DS□306 Series

Compact, high performance EMI suppression filters, DS□306 series can be mounted at 2.54mm pitch. Excellent cost-performance and compact enough to be applied to any type of equipment.

### FEATURES

1. Because of its high noise suppression effect, it can be safely used even where adverse electromagnetic fields exist.
2. Plate type dielectric plus 3-terminal construction produces excellent high-frequency characteristics.

### APPLICATIONS

1. Helps office equipment (such as facsimiles, PPCs, electronic typewriters) meet FCC, VCCI and VDE regulations.
2. Helps peripheral equipment (such as computers and displays, FDDs, printers) meet the FCC, VCCI and VDE regulations.
3. Digital TVs, VCRs.
4. Improves noise resistance of automotive electronics.

### PART NUMBERING

(Please specify the part number when ordering.)



- ① Disc Type EMIFIL®
- ② Ferrite Bead Mounting Condition :  
Blank : Without beads S : Inside
- ③ Type
- ④ Lead Configuration 55 : Straight  
351 : In-crimp
- ⑤ Temperature Characteristics
- ⑥ Capacitance
- ⑦ Capacitance Tolerance
- ⑧ Rated Voltage

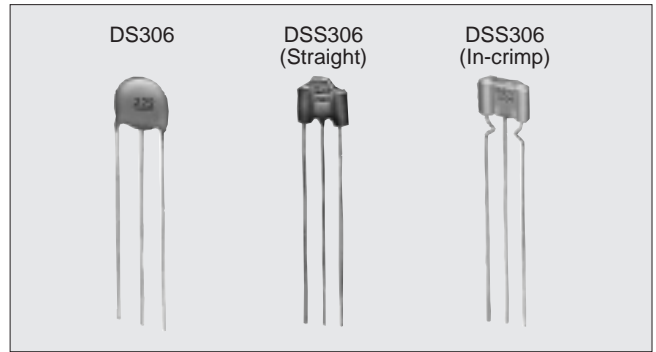

### EQUIVALENT CIRCUIT

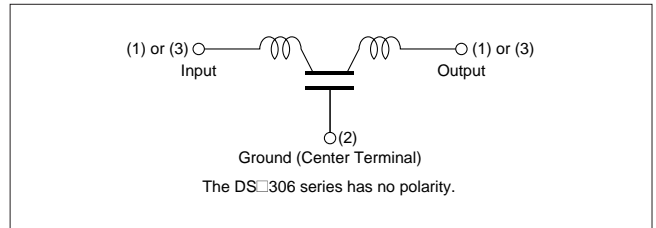

### RATINGS

Item	Rated Values
Rated Voltage	16 – 100Vdc
Rated Current	6A
Withstand Voltage	40 – 250Vdc
Operating Temperature Range	–25 to +85°C
Storage Temperature Range	–25 to +85°C

### DIMENSIONS (Please refer to pages 93 to 94 for taping specs.)

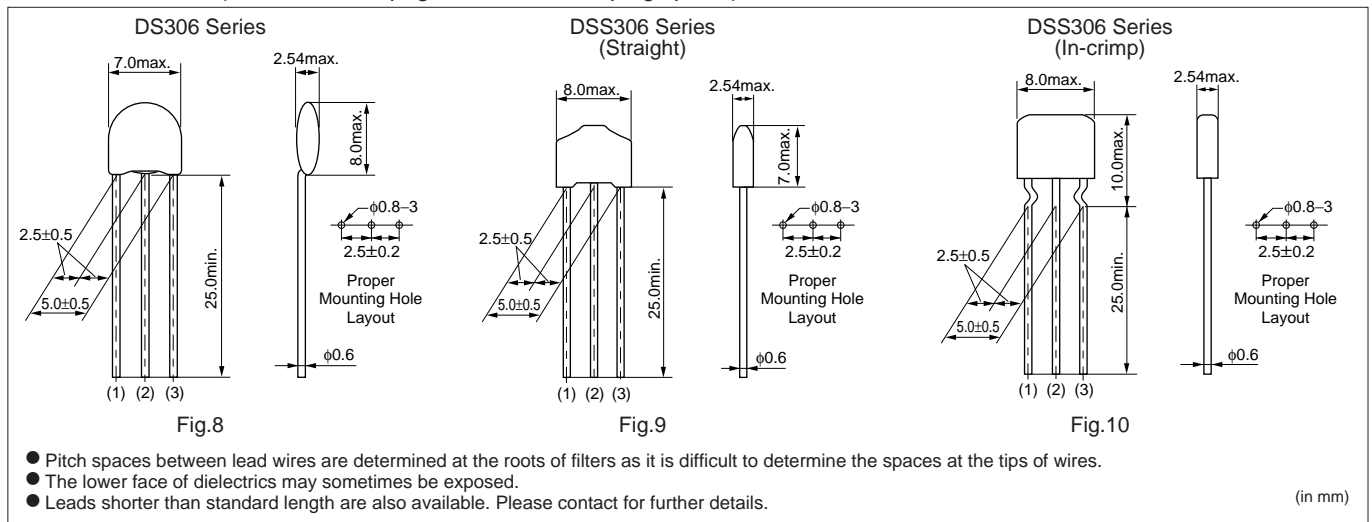

**SPECIFICATIONS** (Please refer to pages 93 to 94 for taping specs.)

www.DataSheet4U.com

Part Number	Insertion Loss Graph	Capacitor			Ferrite Beads	Dimension
		Capacitance	Rated Volt.	Temp. Char.		
DS306-55Y5S220M50	Fig.11-1	22pF±20%	50Vdc	±22%	None	Fig. 8
DS306-55Y5S330M50	Fig.11-2	33pF±20%				
DS306-55Y5S470M50	Fig.11-3	47pF±20%				
DS306-55Y5S101M50	Fig.11-4	100pF±20%				
DS306-55Y5S271M50	Fig.11-5	270pF±20%				
DS306-55Y5S102M50	Fig.11-6	1000pF±20%				
DS306-55Y5S222M50	Fig.11-7	2200pF±20%				
DS306-55FZ103Z50	Fig.11-8	10000pF±20%				
DSS306-□Y5S220M100	Fig.12, 13-1	22pF±20%	100Vdc	±22%	Incorporated	Fig. 9, Fig. 10
DSS306-□Y5S330M100	Fig.12, 13-2	33pF±20%				
DSS306-□Y5S470M100	Fig.12, 13-3	47pF±20%				
DSS306-□Y5S101M100	Fig.12, 13-4	100pF±20%				
DSS306-□Y5S151M100	Fig.12, 13-5	150pF±20%				
DSS306-□Y5S221M100	Fig.12, 13-6	220pF±20%				
DSS306-□Y5S271M100	Fig.12, 13-7	270pF±20%				
DSS306-□Y5S471M100	Fig.12, 13-8	470pF±20%				
DSS306-□Y5S102M100	Fig.12, 13-9	1000pF±20%				
DSS306-□Y5U222Z100	Fig.12, 13-10	2200pF±20%				
DSS306-□FZ103N100	Fig.12, 13-11	10000pF±30%	±30%			
DSS306-□F223Z16	Fig.12, 13-12	22000pF±30%	16Vdc	±30%		

□part shows lead form. (55 : Straight Type, 351 : In-crimp Type)

**INSERTION LOSS CHARACTERISTICS**

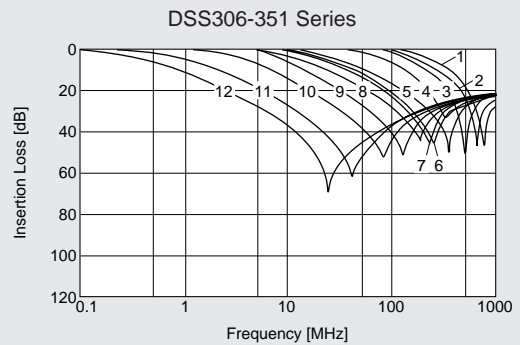
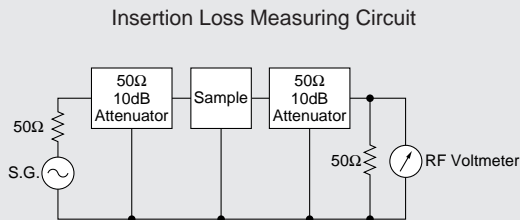

Fig.12

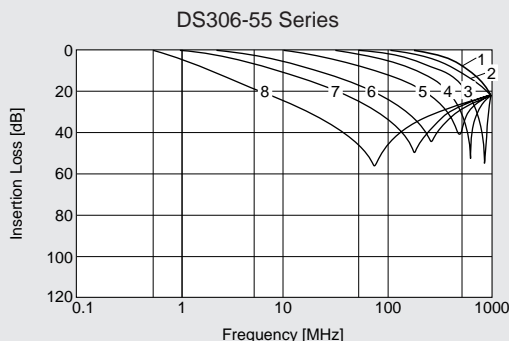

Fig.11

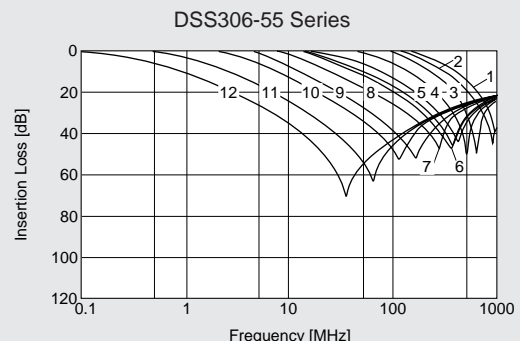
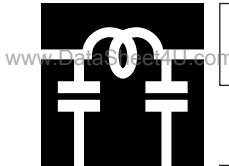

Fig.13



# EMI SUPPRESSION FILTERS

EMIFIL® is the trademark of Murata Manufacturing Co., Ltd.



## Wide Band Disc-Type EMIFIL® DS□310 Series

# High Performance EMI Filter. Large Suppression Effect for Meeting Various Noise Regulations.

DS□310 series is a high performance EMI filter made of large, high performance ferrite bead cores and ceramic capacitors all produced by Murata's unique technology. DS□310 series offers excellent noise suppression and meets various safety standards, such as FCC and CISPR.

### FEATURES

1. By using large ferrite beads, higher attenuation can be obtained in a wide band.
2. Safe to use even under high rated voltage and in electromagnetic environment.
3. Due to the use of plate type dielectrics, residual inductance is small and high frequency characteristics are excellent.
4. High speed mounting can be made by auto insertion machine.
5. Mountable on PCBs. General cost performance is excellent.

### APPLICATIONS

- Suppression of unwanted radiation from computers, peripherals, printers, FDD, word-processors, etc.
- Improvement of noise resistance of car electronic devices such as engine controllers, radios, etc.
- Facsimiles, PPCs, electronic typewriters, other office equipment.
- Noise suppression of other general digital equipment. Meet VCCI, FCC, CISPR, and other regulations.

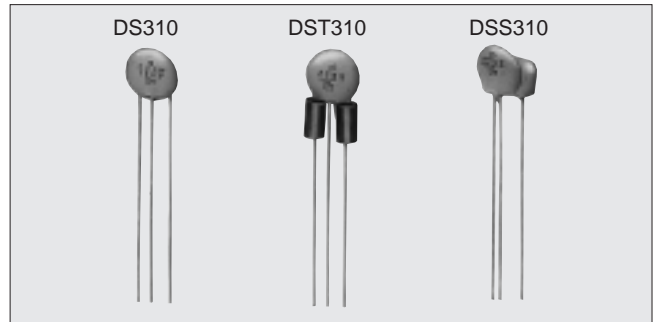

### PART NUMBERING

(Please specify the part number when ordering.)



- ① Disc Type EMIFIL®
- ② Ferrite Bead Mounting Condition :  
Blank : Without beads  
T : Outside  
S : Inside
- ③ Type
- ④ Lead Configuration
- ⑤ Temperature Characteristics
- ⑥ Capacitance
- ⑦ Capacitance Tolerance
- ⑧ Rated Voltage

### EQUIVALENT CIRCUIT

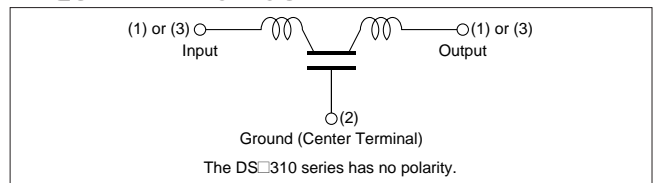

### RATINGS

Item	Rated Values
<b>Rated Voltage</b>	16 – 100Vdc
<b>Rated Current</b>	7A
<b>Withstand Voltage</b>	40 – 250Vdc
<b>Operating Temperature Range</b>	–25 to +85°C

### DIMENSIONS

(Please refer to pages 93 to 94 for taping specs.)

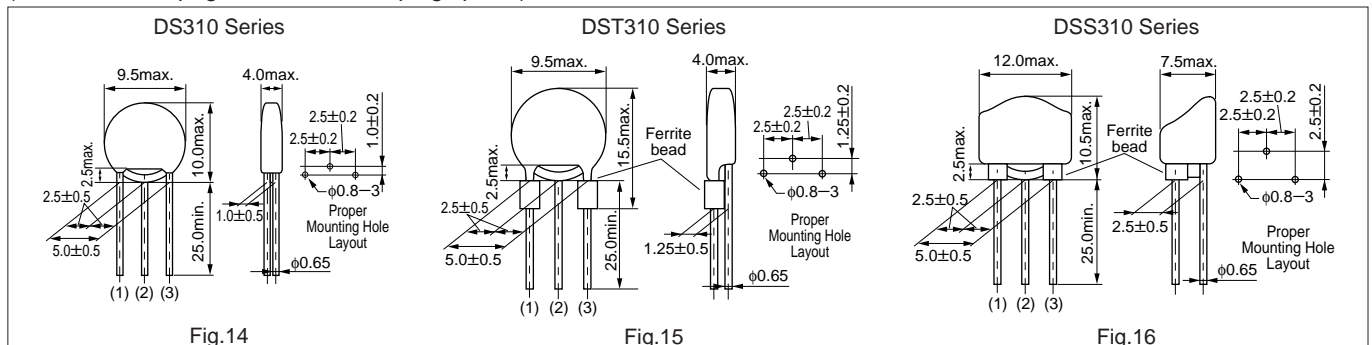

- Pitch spaces between lead wires are determined at the roots of filters as it is difficult to determine the spaces at the tips of wires.
- For lead types, the product with 3-terminals arranged inline and the taping products other than above mentioned ones are available.
- Coating extending on leads does not exceed the tangent line. Exposed electrode, if any, covered by solder, etc.
- Leads shorter than standard length are also available. Please contact for further details.

**■SPECIFICATIONS** (Please refer to pages 93 to 94 for taping specs.)

Part Number	Insertion Loss Graph	Capacitor			Ferrite Beads	Dimension	
		Capacitance	Rated Volt.	Temp. Char.			
DS310-55Y5S271M100	Fig.17	270pF±20%	100V	±22%	None	Fig. 14	
DS310-55Y5S222M100	Fig.18	2200pF±20%	100V				
DS310-55Y5S223S50	Fig.19	22000pF±20%	50V				
DST310-55Y5S271M100	Fig.17	270pF±20%	100V		±22%	Outside	Fig. 15
DST310-55Y5S222M100	Fig.18	2200pF±20%	100V				
DST310-55Y5S223S50	Fig.19	22000pF±20%	50V				
DSS310-55Y5S220M100	Fig.21	22pF±20%	100V			Inside	Fig. 16
DSS310-55Y5S470M100	Fig.21	47pF±20%	100V				
DSS310-55Y5S101M100	Fig.21	100pF±20%	100V				
DSS310-55Y5S271M100	Fig.17	270pF±20%	100V		±22%	None	Fig. 14
DSS310-55Y5S222M100	Fig.18	2200pF±20%	100V				
DSS310-55Y5S223S50	Fig.19	22000pF±20%	50V				
DS310-55Y5S104M16*1	Fig.22	100000pF±20%	16V	±10%		Inside	Fig. 16
DSS310-55BL222M100*2	Fig.20	2200pF±20%	100V				
DSS310-55DL223S50*2	Fig.20	22000pF±20%	50V	±20%			

\*1 With larger capacitance, ideal for decoupling. \*2 Designed exclusively for audio IF circuits

**■INSERTION LOSS CHARACTERISTICS**

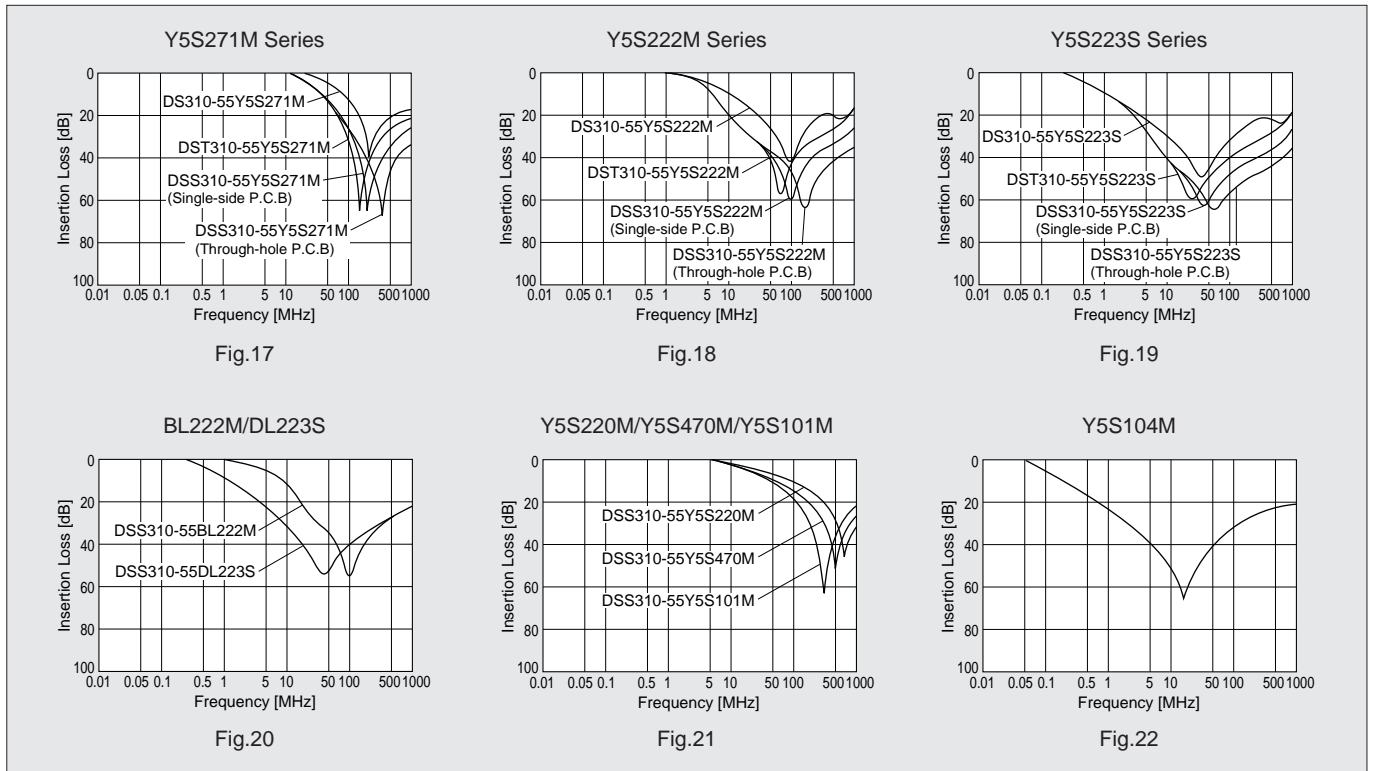

3

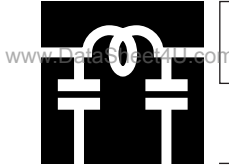

# EMI SUPPRESSION FILTERS

EMIFIL® is the trademark of Murata Manufacturing Co., Ltd.



## Heavy Duty Disc-Type EMIFIL® DS□310H Series

### High Performance EMI Suppression Filter with 250Vdc Rated Voltage

DS□310H series is a high performance EMI suppression filter made of large, high performance ferrite bead cores. This series for the circuits where the DS□306 series and the BL02 series are less effective and where the high rated voltage is required.

#### FEATURES

1. By using large ferrite beads, higher noise suppression effect can be obtained in a wide band.
2. Safe to use even under high rated voltage and in electromagnetic environment.
3. Due to the use of plate type dielectric and of 3-terminal construction, high frequency characteristics are excellent.

#### APPLICATIONS

- Improved noise resistance for automotive electronics.
- Helps office equipment (such as facsimiles, PPCs, electronic typewriters) meet FCC, VCCI and VDE regulations.
- Digital noise suppression for microcomputer controlled home appliance products, and improvement of noise resistance of microcomputer.
- Digital TVs, VCRs.

#### PART NUMBERING

(Please specify the part number when ordering.)



- |  |  |
|--|--|
| <p>① Disc Type EMIFIL®</p> <p>② Ferrite Bead Mounting Condition :<br/>Blank : Without beads<br/>T : Outside<br/>S : Inside</p> <p>③ Type</p> | <p>④ Series Classification</p> <p>⑤ Lead Configuration</p> <p>⑥ Temperature Characteristics</p> <p>⑦ Capacitance</p> <p>⑧ Capacitance Tolerance</p> <p>⑨ Rated Voltage</p> |
|--|--|

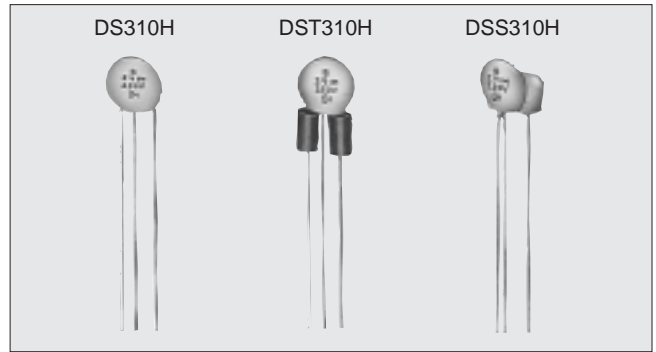

#### EQUIVALENT CIRCUIT

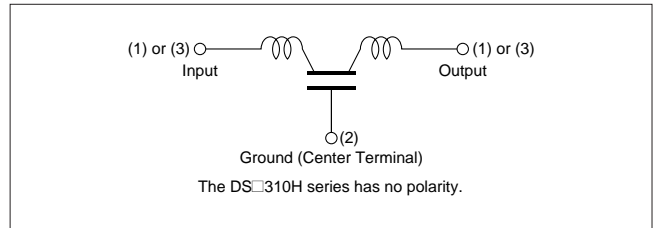

#### RATINGS

Item	Rated Values
Rated Voltage	250Vdc
Rated Current	6A
Withstand Voltage	625Vdc
Operating Temperature Range	-40 to +105°C
Storage Temperature Range	-55 to +105°C

#### DIMENSIONS (Please refer to pages 93 to 94 for taping specs.)

DS310H Series

Fig.23

DST310H Series

Fig.24

DSS310H Series

Fig.25

● Pitch spaces between lead wires are determined at the roots of filters as it is difficult to determine the spaces at the tips of wires.  
 ● For lead types, the product with 3-terminals arranged in line and the taping products other than above mentioned ones are available.  
 ● Coating extending on leads does not exceed the tangent line. Exposed electrode, if any, covered by solder, etc.  
 ● Leads shorter than standard length are also available. Please contact for further details.

(in mm)

3

**■SPECIFICATIONS** (Please refer to pages 93 to 94 for taping specs.)

Part Number	Insertion Loss Graph	Capacitance Tolerance	Capacitance Temperature Characteristic		Ferrite Beads	Dimension				
			-25 to +85°C	-40 to +105°C						
DS310H-55B220M250	Fig.26	22pF±20%	±10%	±20%	None	Fig.23				
DST310H-55B220M250	Fig.27				Outside	Fig.24				
DSS310H-55B220M250	Fig.28				Inside	Fig.25				
DS310H-55B101M250	Fig.26	100pF±20%			±10%	±20%	None	Fig.23		
DST310H-55B101M250	Fig.27						Outside	Fig.24		
DSS310H-55B101M250	Fig.28						Inside	Fig.25		
DS310H-55B271M250	Fig.26	270pF±20%					±10%	±20%	None	Fig.23
DST310H-55B271M250	Fig.27								Outside	Fig.24
DSS310H-55B271M250	Fig.28								Inside	Fig.25
DS310H-55B222M250	Fig.26	2200pF±20%							±10%	±30%
DST310H-55B222M250	Fig.27		Outside	Fig.24						
DSS310H-55B222M250	Fig.28		Inside	Fig.25						

**■INSERTION LOSS CHARACTERISTICS** (Central Value : 50Ω system)

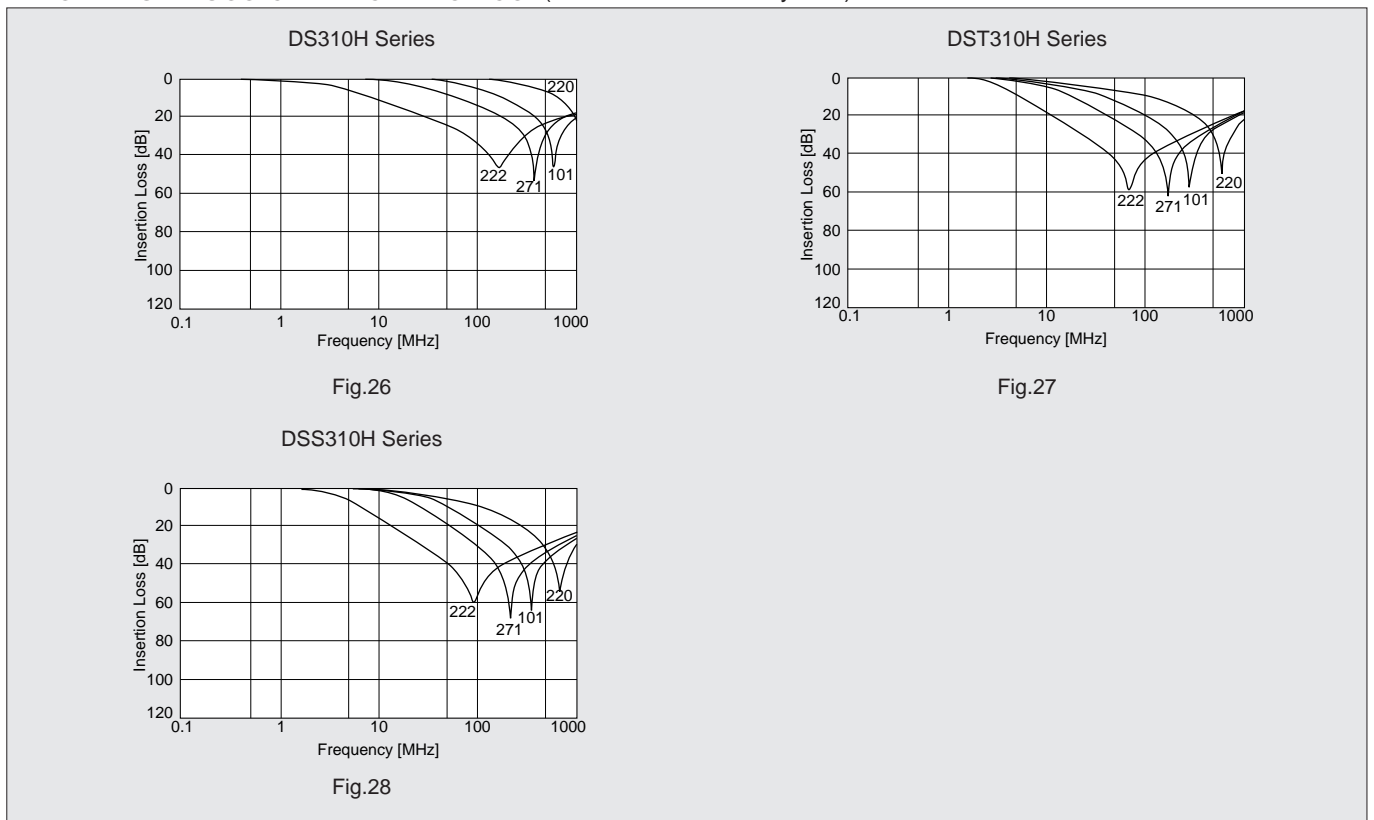

3

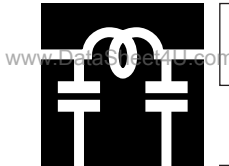

# EMI SUPPRESSION FILTERS

EMIFIL® is the trademark of Murata Manufacturing Co., Ltd.



## EMIGUARD® VFR303/DSS706/DSS710 Series

### 3-Terminal varistor-capacitor EMI filter. Enables simultaneous EMI suppression and surge protection

The EMIGUARD® VFR303, DSS706, and DSS710 series EMI suppression filters incorporate capacitors that have a varistor function to enable simultaneous EMI noise suppression and surge protection functions. These varistor-enabled capacitors act not only as bypass capacitors against noise but also as surge protectors that route most of the surge current from high voltage power surges to ground to protect the circuits. Furthermore, the three-terminal structure provides excellent performance characteristics in the high-frequency range, making these filters effective against high-frequency noise and short rise-time surges which are difficult to combat with ordinary capacitors and varistors. The VFR303 series is for protecting semiconductor devices, the DSS706 series is for use on signal lines, and the DSS710 series is for use on power supply lines.

#### ■PART NUMBERING

(Please specify the part number when ordering.)

##### ● VFR303 Series

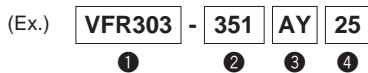

- ① Type
- ② Lead Configuration  
(351 : Bulk, 431 : Taped)
- ③ Characteristics
- ④ Rated Voltage

##### ● DSS706 Series



- ① Type
- ② Lead Configuration
- ③ Temperature Characteristics
- ④ Capacitance Tolerance
- ⑤ Rated Voltage
- ⑥ Varistor Voltage

##### ● DSS710 Series

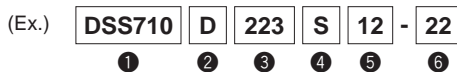

- ① Type
- ② Temperature Characteristics
- ③ Capacitance Value
- ④ Capacitance Tolerance
- ⑤ Rated Voltage
- ⑥ Varistor Voltage

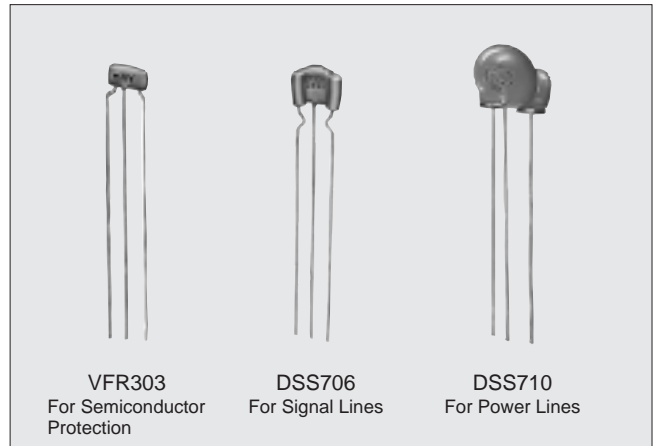

#### ■DIMENSIONS

(Please refer to pages 93 and 94 taping specs.)

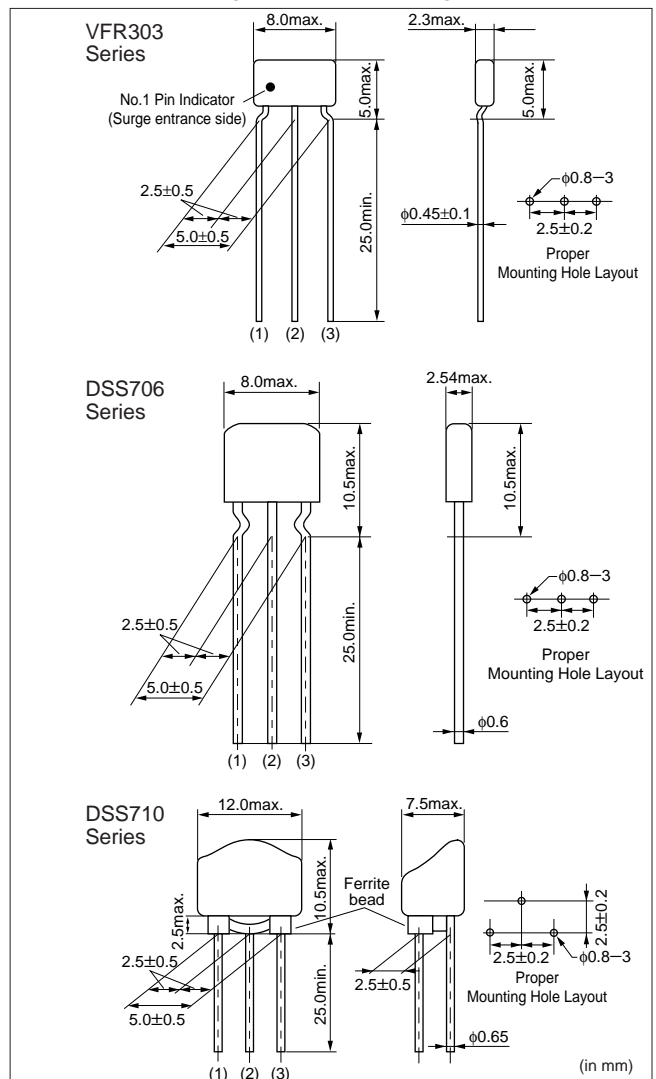



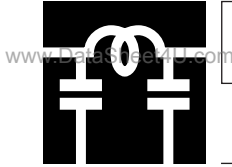

# EMI SUPPRESSION FILTERS

EMIFIL® is the trademark of Murata Manufacturing Co., Ltd.



## EMIGUARD® for Semiconductor Protection VFR303 Series

### FEATURES

1. Absorb ESD surge rushed into IC's I/O terminal efficiently, protect IC from destruction.
2. Thin and low height shape enables high density mounting.  
[The volume ratio 57% in comparison with conventional EMIFIL® (DSS306)]

### APPLICATIONS

Elimination of noise and protection of semiconductors in office equipments, including computers and peripheral equipments, copy machines, and communication terminals.

### APPLICATIONS (VFR303-351 AY 25)

Item	Specification	Item	Specification
Rated Voltage (Between Terminals (1)-(2))	25Vdc	Capacitance (Between Terminals (1)-(2))	130pF±20%
Varistor Voltage (Between Terminals (1)-(2))	50Vdc±20%	Capacitance Temp. Char.	±20/30%
Rated Current (Between Terminals (1)-(3))	20mA dc	Insulation Resistance (Between Terminals (1)-(2))	10MΩ min.
Peak Pulse Current (Between Terminals (1)-(2))	15A	DC Resistance (Between Terminals (1)-(3))	150Ω±35%
ESD Test (150pF, 330Ω) (Between Terminals (1)-(2))	15kV 100times	Operating Temp. Range	-25 to +85°C

### INSERTION LOSS CHARACTERISTICS (TYPICAL)

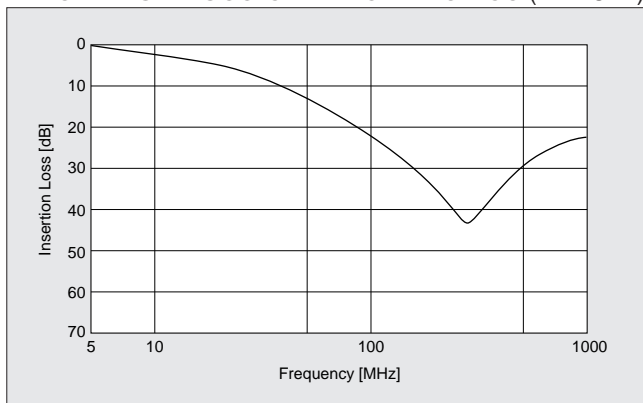

### APPLICATION

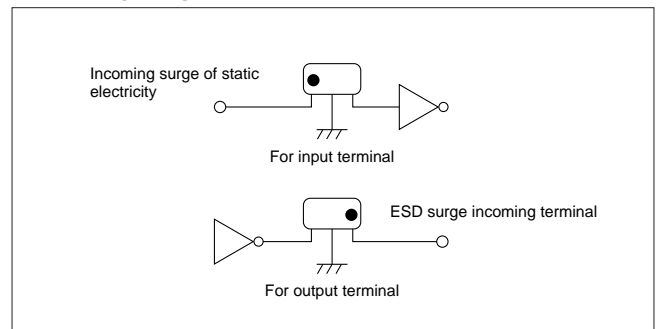

Please connect 1st terminal (marked terminal) to ESD surge incoming line. (Please pay attention for direction.)

### INSERTION LOSS MEASURING CIRCUIT

Measurement is performed by using 50Ω-3kΩ measuring circuits in order to match operating conditions of the digital signal circuit.

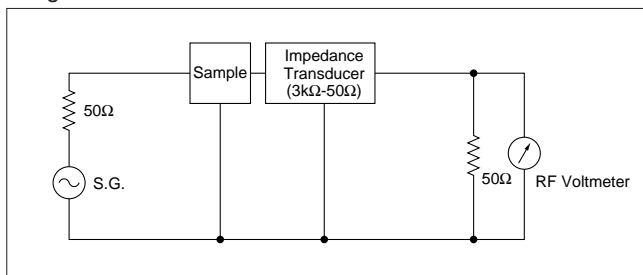



■EXAMPLE OF IC PROTECTION

●Testing Method

1. Put ESD surge to IC (7404 family) input terminal with ESD simulator based on IEC 801-2.
2. Check IC's operation.
3. If IC's operation is normal, increase ESD voltage in 1kV step.
4. Continue above steps 1 to 3 till IC's operation become abnormal.

Test Circuit

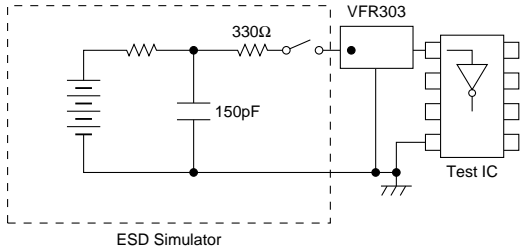

Result

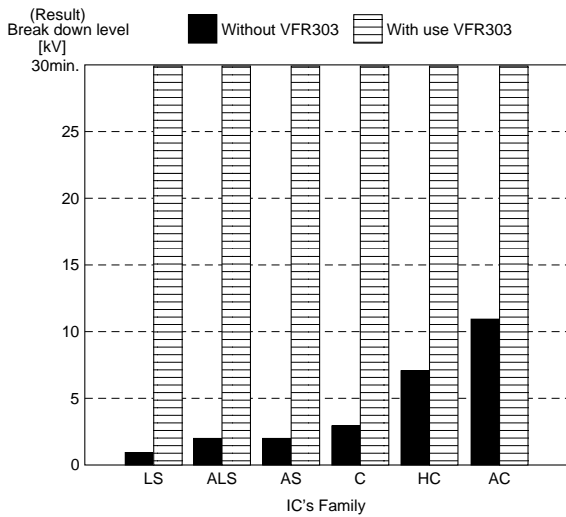

■EXAMPLE OF EMI SUPPRESSION EFFECT

Test Circuit

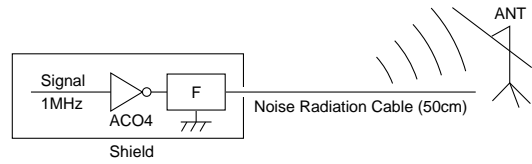

Before Countermeasures: No Filters

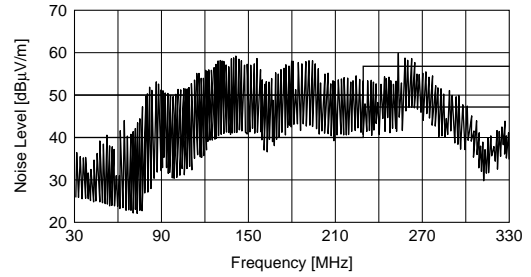

Use VFR303-351 AY 25

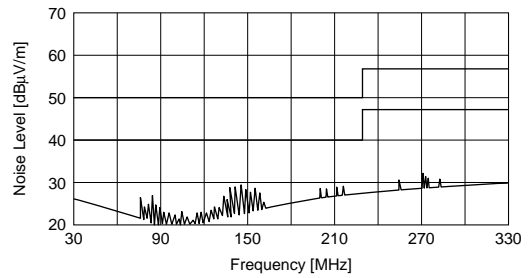

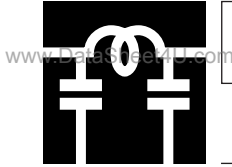

# EMI SUPPRESSION FILTERS

EMIGUARD® is the trademark of Murata Manufacturing Co., Ltd.



## EMIGUARD® for Signal Lines DSS706 Series

### ■FEATURES

1. Protects electric circuit from surges such as static electricity, acts as a filter for signal line immunity.
2. Small size enables it to be mounted at 2.54mm pitch. 3-terminal structure leads to superior high frequency characteristics.
3. Built-in ferrite bead gives excellent EMI suppression.

### ■APPLICATIONS

Elimination of noise and protection of semiconductors in office automation equipment, including computers and their peripheral equipment, copy machines, and communication terminals.

### ■SPECIFICATIONS (DSS706-351D221M25-50)

Item	Specification	Item	Specification
Rated Voltage	25Vdc	Capacitance	220pF±20%
Varistor Voltage	50Vdc±20%	Capacitance Temp. Char.	±30%
Rated Current	6Adc	Insulation Resistance	50MΩ min.
Peak Pulse Current	100A	Operating Temp. Range	-40 to +105°C

### ■INSERTION LOSS CHARACTERISTICS (50Ω system)

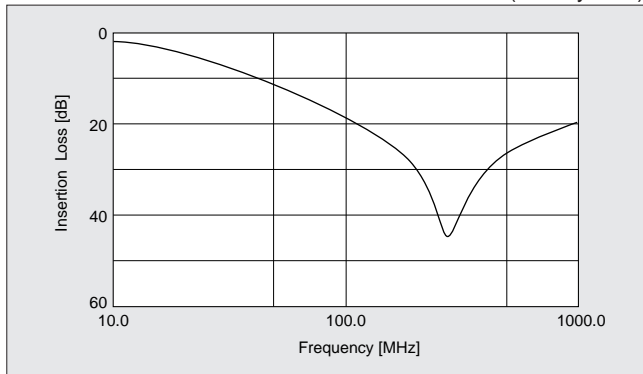

### ■EXAMPLE OF HIGH-VOLTAGE PULSE RESPONSE

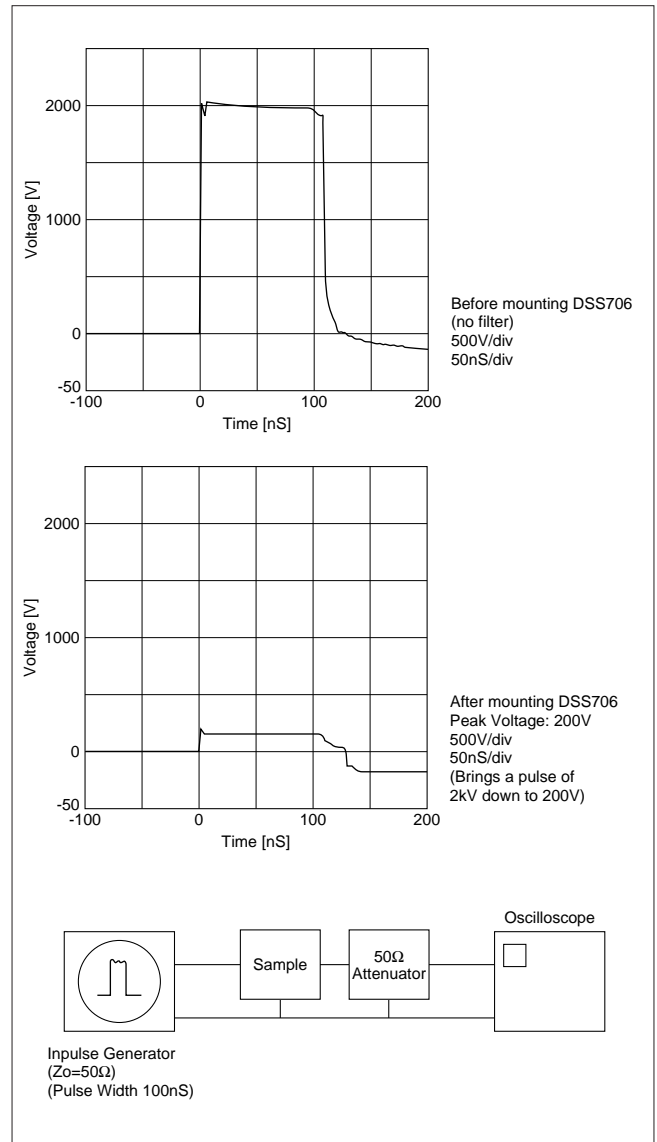

### ■VOLTAGE-CURRENT CURVE

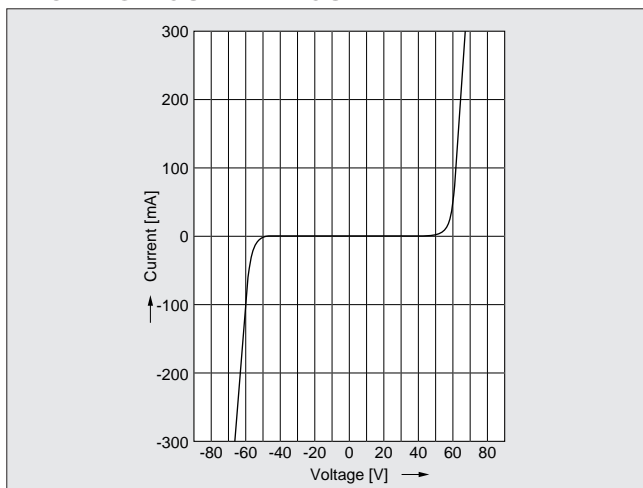

### ■EQUIVALENT CIRCUIT DIAGRAM

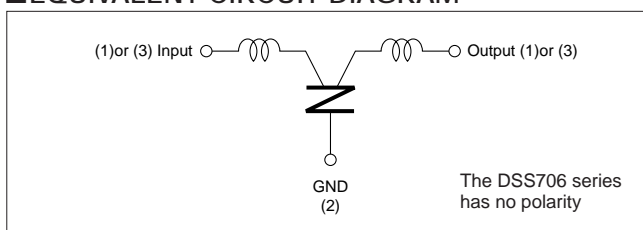

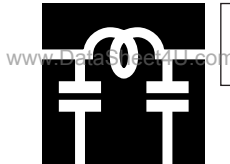

# EMI SUPPRESSION FILTERS

EMIGUARD® is the trademark of Murata Manufacturing Co., Ltd.



## EMIGUARD® for Power Lines DSS710 Series

### FEATURES

Large capacitance values make this series ideal for EMI noise suppression and surge protection both on power supply lines and on low-speed signal lines.

### APPLICATIONS

For circuit protection and noise suppression in electronics equipment such as computers and Dc motors and in electronics systems installed in cars such as car audio equipment and engine controllers.

### INSERTION LOSS CHARACTERISTICS (50Ω system)

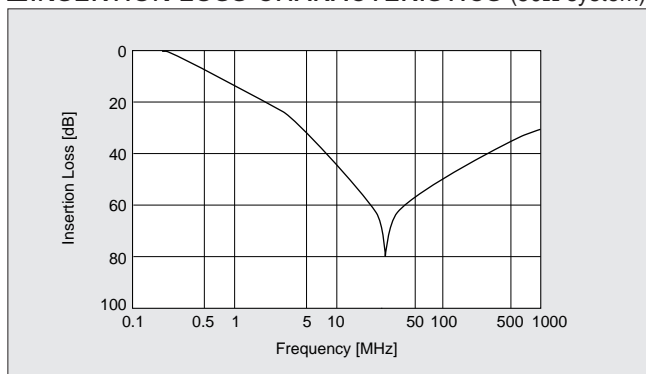

### EQUIVALENT CIRCUIT DIAGRAM

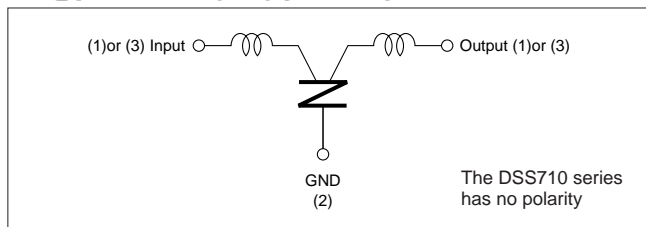

### SPECIFICATIONS (DSS710D223S12-22)

Item	Specification
Rated Voltage	12Vdc
Varistor Voltage	22Vdc±20%
Rated Current	7Adc
Voltage Ratio	1.25 max.(V10mA/V1mA)*
ESD Test (150pF, 330Ω)	25kV, 10times
Capacitance	22000pF±5%
Capacitance Temp. Char.	±30% (-25 to +85°C)
Insulation Resistance	1MΩ min.(applied DC 10V)
Operating Temp. Range	-40 to +100°C

\*V10 : Voltage when 10mA is applied

\*V1 : Voltage when 1mA is applied

### VOLTAGE-CURRENT CURVE

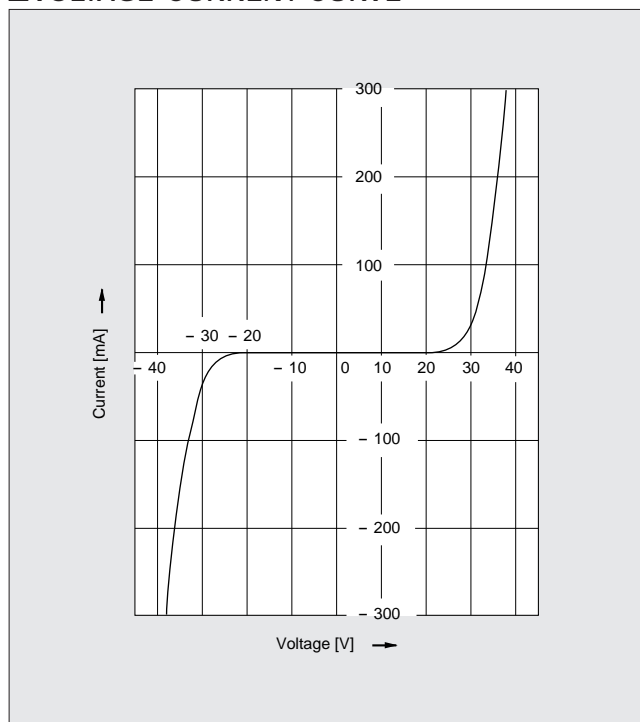

### APPLICATION

Systems	Lines to be connected	Effects
Engine Controllers	Power lines, I/O lines for low-frequency current	Protection of systems from excessive voltage. Prevents ignition noise, thunder surges, etc. From causing malfunctions.
Automobile Audio Equipment	Power lines, audio output lines	Protection of systems from excessive voltage. Prevents ignition noise from influencing audio current.
Computers	Power lines, I/O lines for low-frequency current	Protection of systems from excessive voltage. Prevents radiation and conduction noise.
DC Motors	Power lines	Prevention of brush noise.

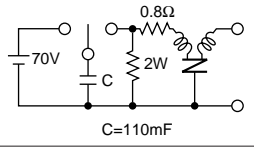

FEATURES

Items	Rated values	Test methods
Overload		1.4 times the varistor voltage ( $V_1$ ) is applied for 5 minutes at room temperature.
Surge Test (I)		At room temperature. Surge are applied are $10^5$ times every 2 seconds. Then after 1 or 2 hours, the sample is measured.
Surge Test (II)	Rated Capacitance Change : Within $\pm 15\%$ Insulation Resistance : $500k\Omega$ min. Rated of Change in Varistor Voltage $V_1^*$ : Within $\pm 15\%$ Voltage Rate : 1.30 max.	At room temperature. Capacitor "C" is changed with 70V, then discharged to apply the voltage to the sample. Tested once (resuming JASO A-1). 
High Temperature Load		At a temperature of $85\pm 3^\circ\text{C}$ . The varistor voltage $V_1$ is continuously applied to the sample for 1000 to 1024 hours. Then it is left at room temperature, for 4 to 24 hours before measuring.

\* $V_1$  : Voltage when 1mA is applied

PULSE-VOLTAGE BREAKDOWN CHARACTERISTIC

The DSS710 EMIGUARD® use a self healing varistor- capacitor, so that it can be used under a 500 to 600V surge which would break conventional disk type EMI filters. As shown in figure below the EMIGUARD® withstands 2000V impulses applied 1000 times.

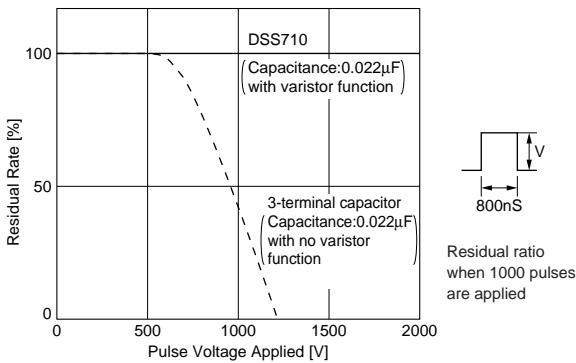
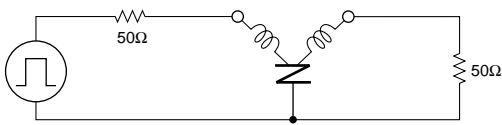

NOISE ABSORPTION EFFECT OF EMIGUARD®

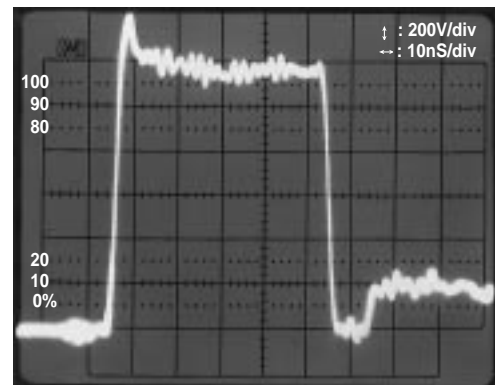

Waveform when EMIGUARD® is not used. (Surge from a noise simulator)

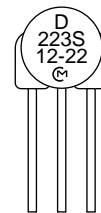

EMIGUARD® is used to suppress the surge shown at left.

EMIGUARD® capable of removing even 1200V surge

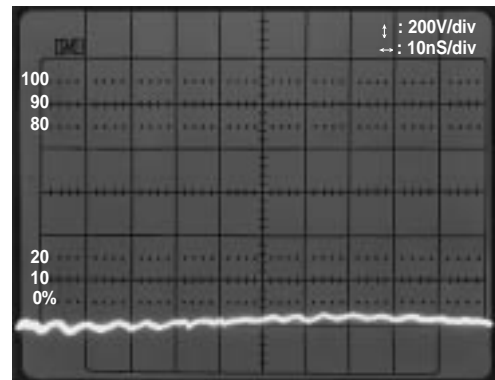

Waveform after the noise passed through EMIGUARD®. Little noise is recorded.

TEMPERATURE CHARACTERISTICS OF VARISTOR VOLTAGE-INSULATION RESISTANCE

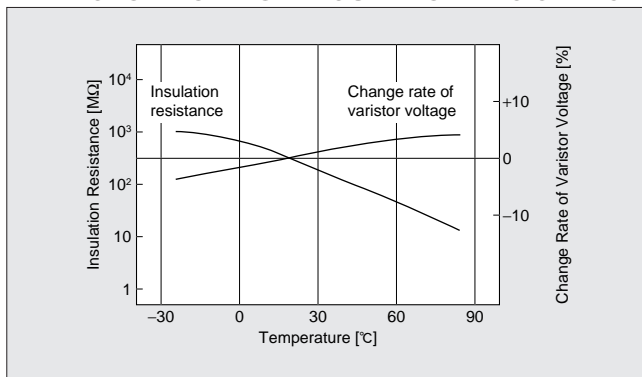

**COMPARATIVE DATA**

**(1) Absorption of quick-rising, high-frequency noise (10nS/div, 100V/div)**

www.DataSheet4U.com

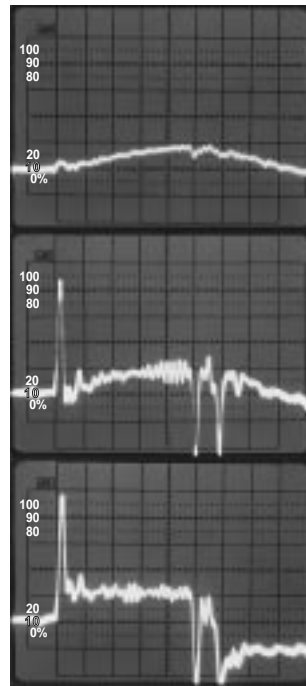
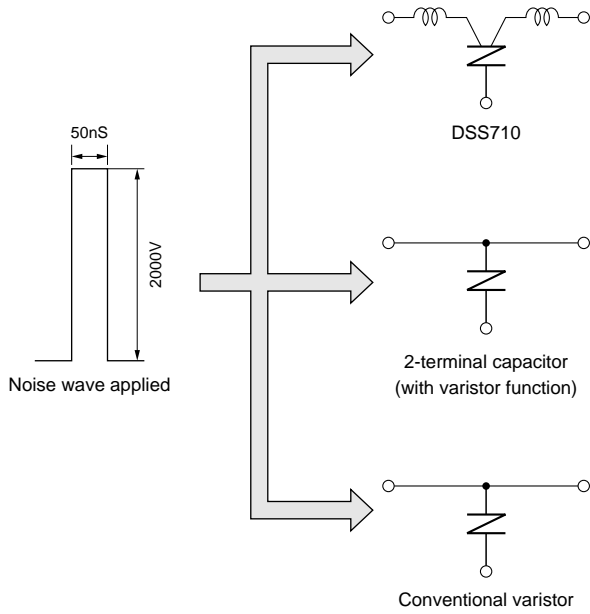

The 3-terminal structure eliminates most of the lead line inductance. This allows the DSS710 to completely absorb the rising and falling edges of the applied pulses.

The 2-terminal capacitor is influenced by lead line inductance, leaving behind some of the rising and falling edges. The residual noise can cause system to malfunction.

As with the 2-terminal capacitor.

**(2) Absorption of wide-pulse noise (50nS/div, 200V/div)**

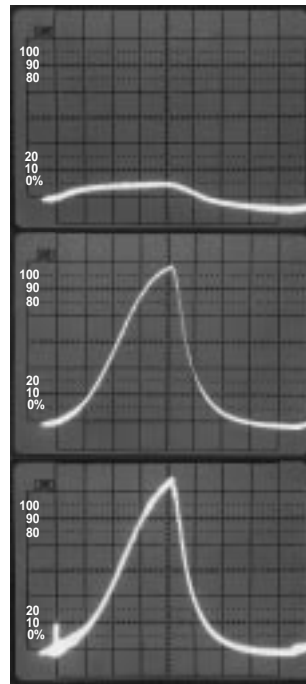
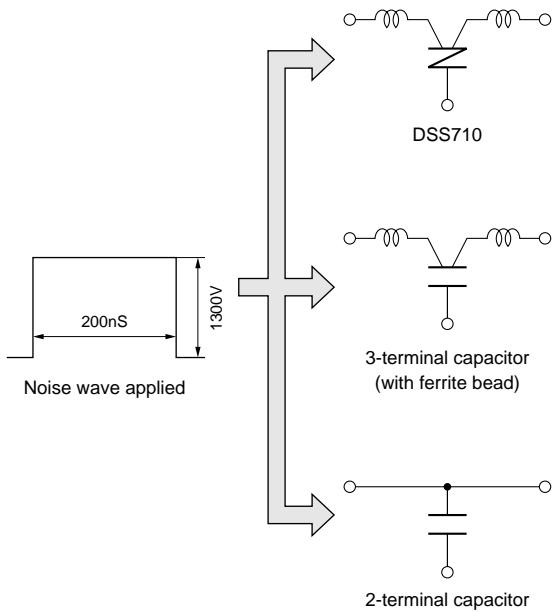

Bypassing high-voltage, the varistor-capacitor utilizes its varistor function to suppress surge. Thus, circuits are protected from breakdown.

Conventional EMI filters do not work for wide-pulse noise because capacitors are saturated. In this example, the residual 1200V surge can cause system to breakdown.

In case of capacitors, the voltage of the residual surge, 1300V is higher than that of the above example. The wave height is almost the same as the original.



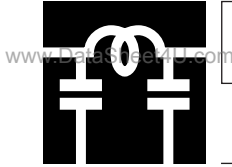

# EMI SUPPRESSION FILTERS

EMIFIL® is the trademark of Murata Manufacturing Co., Ltd.



EMIFIL® for Automatic Insertion DS□306/310/310H, DSS706/710, VFR303 Series

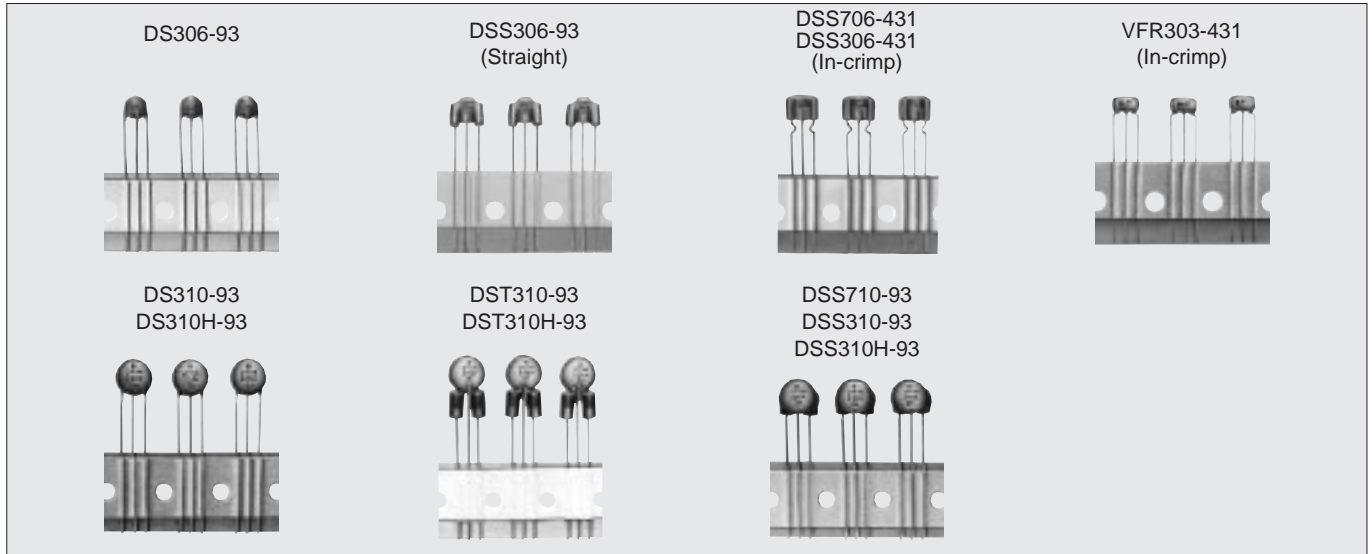

Any Type of bulk DS□306, DS□310/310H, DSS706/710, VFR303, series can be taped for automatic insertion.

## ■PART NUMBERING

(Please specify the part number when ordering.)

(Ex.) DSS306-**93** Y5S271M100  
 DSS306-**431** Y5S271M100

● Same as the bulk type except the number changed in box.

Code		Lead length (H)
Straight	In-crimp	
-91	-	20 mm
-92	-421	16.5mm
-93	-431	18.5mm
Part Number	Part Number	
● DS□306 •DS□310H	● DSS306	
● DS□310 •DSS710	● DSS706 (-431 only)	
	● VFR303 (-431 only)	

## ■MOUNTING HOLE

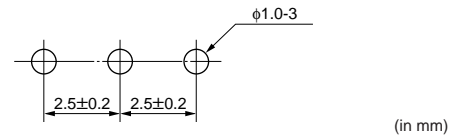

## ■RACKAGING TYPE AND QUANTITY

Part Number	Minimum Order Quantity (order in sets only) (Pcs.)	
	Flat Pack	Reel
VFR303 Series	2000	-
DS□306/DSS706 Series	2000	-
DS310/310H Series	2000	-
DST310/310H Series	1000	-
DSS310/310H/710 Series	-	800

## ■RATINGS

1. Allowable current is 6A.
2. All other ratings are the same as those of bulk types.  
(Refer to pages 80 to 92)

**TAPING DIMENSIONS**

www.DataSheet4U.com

DS306-93 Type  
DS310/310H-93 Type

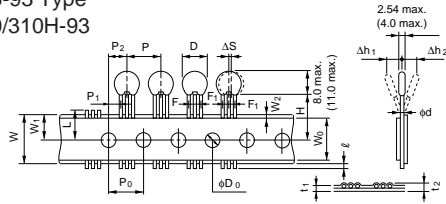

DST310/310H-93 Type

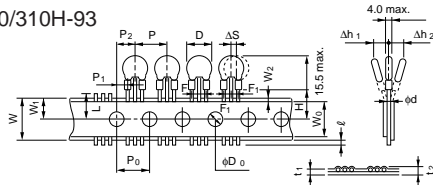

DSS310/310H-93 Type  
DSS710-93 Type

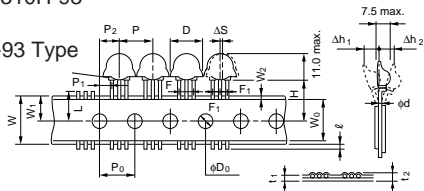

DSS306-93 Type

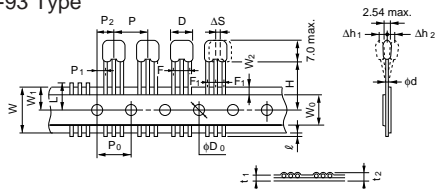

DSS306-431 Type  
DSS706-431 Type

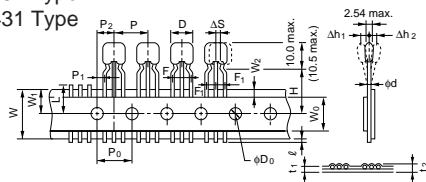

VFR303-431 Type

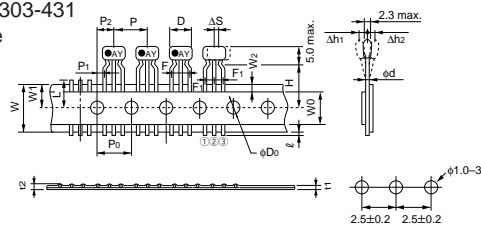

Item	Code	Dimensions (mm)	Remarks
Pitch of Component	P	12.7	Product inclination ΔS determines tolerance
Pitch of Sprocket Hole	P <sub>0</sub>	12.7±0.2	
Length from Hole Center to Component Center	P <sub>1</sub>	3.85±0.7	
Width of Body	D	7.0 max.	DS306
		8.0 max.	DST (S)306/DSS706/VFR
		9.5 max.	DS310 (H)/DST310 (H)
Deviation along Tape, Left or Right	ΔS	0±1.0	
		12.0 max.	DSS310 (H) DSS710
Carrier Tape Width	W	18.0±0.5	
Position of Sprocket Hole	W <sub>1</sub>	9.0±0.5	Tape width deviation
Protrusion Length	ℓ	+0.5 to -1.0	
Diameter of Sprocket Hole	D <sub>0</sub>	φ 4.0±0.1	
Lead diameter	d	φ 0.6	φ 0.45±0.1 (VFR)
Total Tape Thickness Total Thickness, Tape and Lead Wire	t <sub>1</sub>	0.7±0.2	Including bonding tape thickness
	t <sub>2</sub>	1.5 max.	
Deviation across Tape	Δh <sub>1</sub>	1.0 max.	
	Δh <sub>2</sub>	1.0 max.	
Portion to Cut in Case of Defect	L	11.0±0.5	
Hold Down Tape Width	W <sub>0</sub>	12.0±0.5	
Hold Down Tape Position	W <sub>2</sub>	1.5±1.5	
Lead Distance between Reference and Bottom Planes	H	18.5±1.0	16.5 mm and 20.0 mm lengths are also available (Except of DSS706/VFR series)
Lead Spacing	F	5.0±0.2	
	F <sub>1</sub>	2.5±0.2	

(in mm)



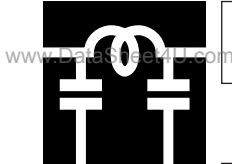

# EMI SUPPRESSION FILTERS

EMIFIL® is the trademark of Murata Manufacturing Co., Ltd.



## EMIFIL® for Automatic Insertion **BL01/02/03** Series

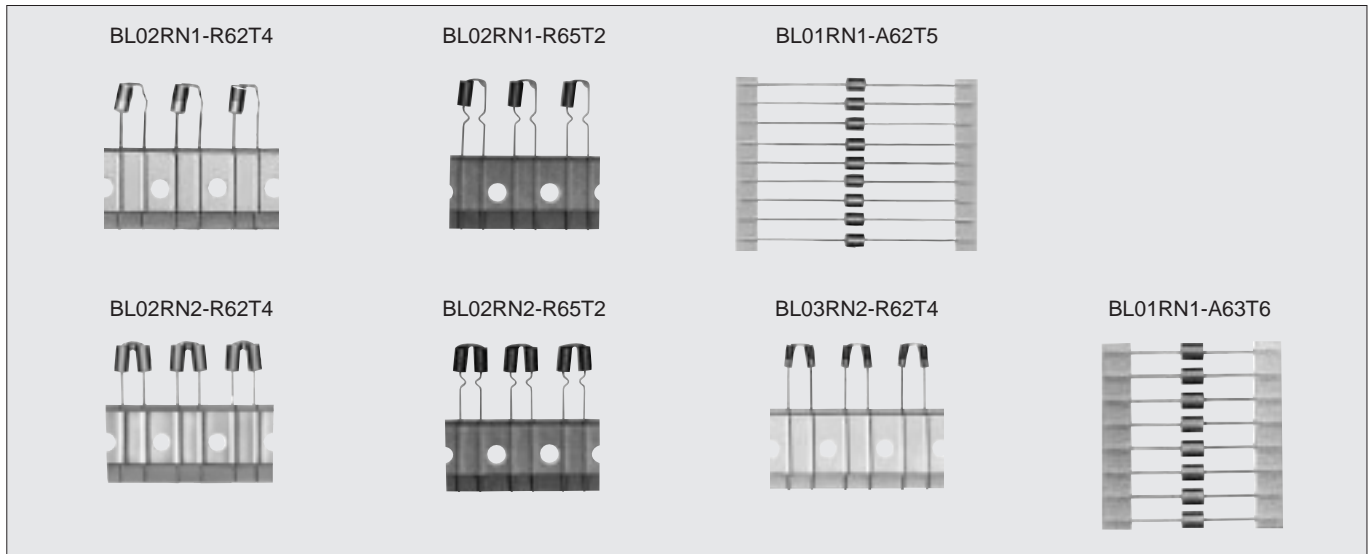

Any Type of bulk BL01/02/03 series can be taped for automatic insertion. (Except for BL01RN1-A62B1)

### ■PART NUMBERING

(Please specify the part number when ordering.)

Code	Description
T2	Radial Type H=16.5mm
T4	Radial Type H=18.5mm
T5	Axial Type Tape Width 52mm
T6	Axial Type Tape Width 26 mm

(Ex.) BL02RN1-R65 **T2**  
 BL02RN2-R62 **T4**  
 BL01RN1-A62 **T5**  
 BL01RN1-A63 **T6**

- Same as the bulk type with the only exception of taping specs stated in the box. (NOTE : A63 applies only when designed as T6.)

### ■RATINGS

1. Allowable current is 6A.
2. All other ratings are the same as those of bulk types. (Refer to pages 78 to 79)

### ■PACKAGING TYPE AND QUANTITY

Part Number	Minimum Order Quantity (order in sets only) (Pcs.)	
	Flat Pack	Reel
BL01RN1-A62T5	-	2000
BL01RN1-A63T6	1000	-
BL02RN1-R62T4	1500	-
BL02RN1-R65T2	1500	-
BL02RN2-R62T4	1500	-
BL02RN2-R65T2	1500	-
BL03RN2-R62T4	2000	-

3





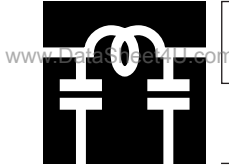

# EMI SUPPRESSION FILTERS

EMIFIL® is the trademark of Murata Manufacturing Co., Ltd.



## Block Type EMIFIL® BNP/BNX Series

# Completely Eliminates Noise in a Wide Range of Complex Circuits from 0.5MHz to 1GHz Mountable on Any Type of P.C. Board

Murata's new block type EMIFIL® BNP/BNX series completely eliminate noise from extremely wide frequency bands. The BNX is perfect for use in DC power circuits, while the BNP is ideal for eliminating noise in logic signal circuits. Both are designed to perform superbly the result of Murata's wide expertise in the fields of through-type barrier layer capacitors, monolithic chip capacitors and bead

inductors.

Each block contains a number of compact EMI suppression filters. In addition, the input/output terminals and the grounding terminal are aligned in the same direction, thus permitting fast and easy assembly on any type of P.C. board.

### BNP

[for signal circuit]



BNP002-02

BNP002-03

BNP004-02

#### ■FEATURES

1. The EMIFIL® BNP002 incorporates through-type barrier layer capacitors and  $\pi$  circuits, allowing it to obtain significantly large insertion losses throughout an extremely wide frequency range from 15MHz up to 1GHz.
2. The cut-off frequency is designed to be at several MHz, which is ideal for eliminating noise from any circuit in which the signal frequency and the noise frequency are relatively close together.
3. Since all noise in plural signal lines can be eliminated by one filter block, the filter is extremely compact.
4. There are no connection routes in the current circuits, thus ensuring highly reliable performance.
5. Both the input/output terminals and the grounding terminal are aligned in the same direction, permitting fast and easy installation on any type of P.C. board.

#### ■APPLICATIONS

Noise elimination from signal lines and DC power sources in engine control units, digital equipment and computer terminals.

### BNX

[for DC power supply]

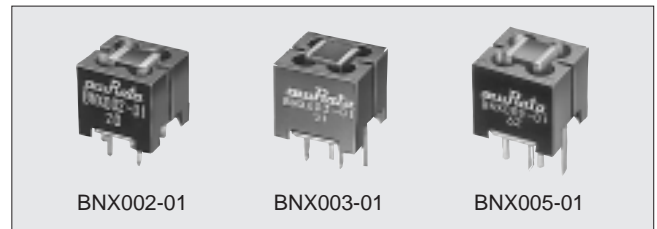

BNX002-01

BNX003-01

BNX005-01

#### ■FEATURES

1. The EMIFIL® BNX002 incorporates a through-type barrier layer capacitor and a four-terminal capacitor which are interconnected. This combination enables the BNX002 to achieve a significantly large insertion loss throughout the extremely wide frequency range of 0.5MHz to 1GHz which covers the AM and UHF-TV broadcast frequency bands.
2. The filter is extremely compact since only one filter block is needed to completely eliminate noise from both the positive and negative lines.
3. There are no connection routes in the current circuits, thus ensuring highly reliable performance.
4. Both the input/output terminals and the grounding terminal are aligned in the same direction, permitting fast and easy installation on any type of P.C. board.
5. BNX003-01 features high dielectric constant, that is the rated voltage 150V.

#### ■APPLICATIONS

Noise elimination from DC power sources in a variety of switching power sources, engine control units, digital equipment and computer terminals.

#### ■EFFECTIVE FREQUENCY RANGE OF BNP/BNX SERIES (IN CASE OF LINE IMPEDANCE 50Ω)

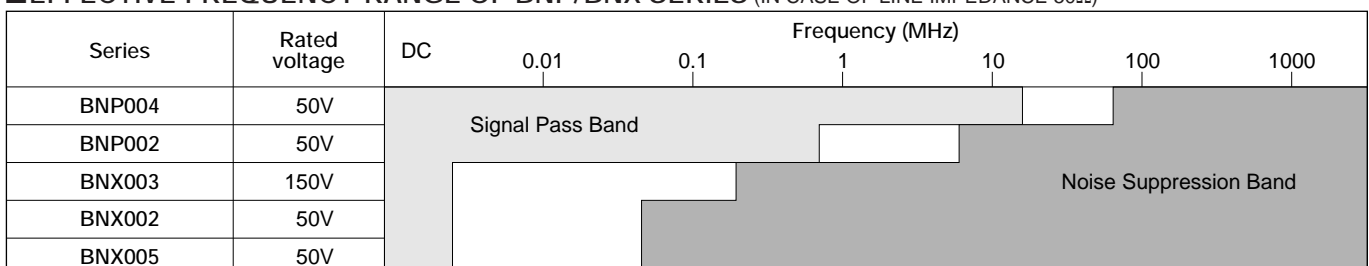

**πType EMI Suppression Filter BNP Series**

www.DataSheet4U.com

**■ SPECIFICATIONS**

Part Number	BNP002-02	BNP002-03	BNP004-02
Number of Circuits	2	3	2
Circuit Construction	π		
Operating Temp. Range	-40 to +100°C		
Rated Voltage	50Vdc		
Withstand Voltage	300Vdc		125Vdc
Rated Current	10Adc		
Insulation Resistance	1000MΩ min.		
DC Resistance	0.05Ω max. (20 to 25°C)		
Insertion Loss	20MHz to 500MHz : 40dB min. (20 to 25°C)		300MHz to 1000MHz : 40dB min. (20 to 25°C)

**■ INSERTION LOSS CHARACTERISTICS**

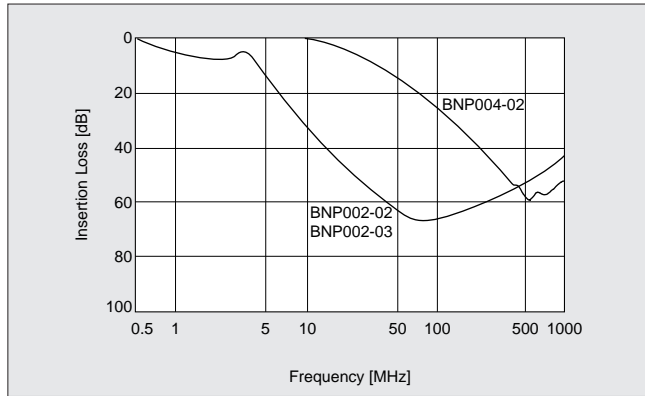

**■ INSERTION LOSS MEASURING CIRCUIT**

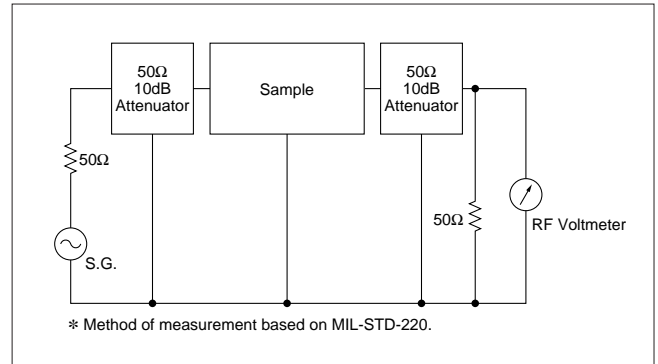

**■ EQUIVALENT CIRCUIT**

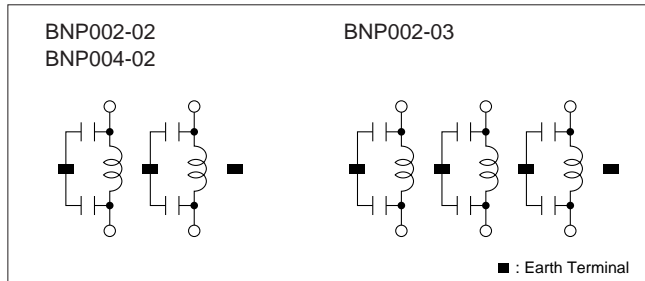

**■ DIMENSIONS OF MOUNTING HOLES**

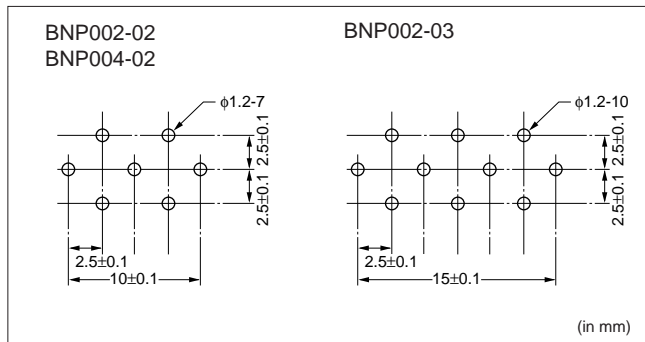

**■ EXTERNAL DIMENSIONS**

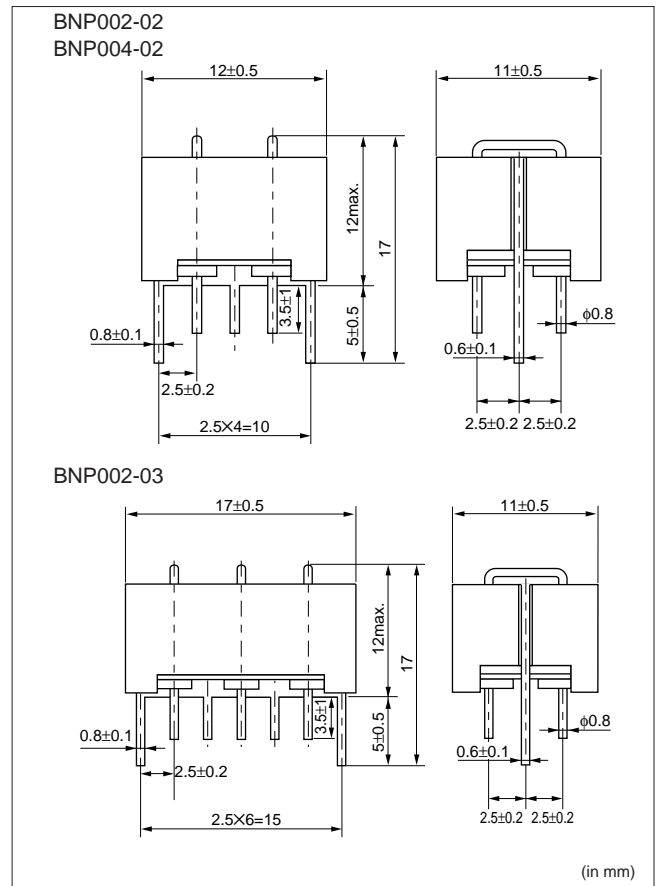

3

# Wide Band Noise Suppression Filters for DC Power Line BNX Series

www.DataSheet4U.com

## ■ SPECIFICATIONS

Part Number	BNX002-01	BNX003-01	BNX005-01
Operating Temp. Range	-30 to +85°C		
Rated Volt.	50Vdc	150Vdc	50Vdc
Withstand Volt.	125Vdc	375Vdc	125Vdc
Rated Current	10Adc		15Adc
Insulation Resistance	100MΩ min.		
Insertion Loss	1MHz to 1GHz : 40dB min.		
	20 to 25°C (line impedance=50Ω)		

## ■ INSERTION LOSS CHARACTERISTICS

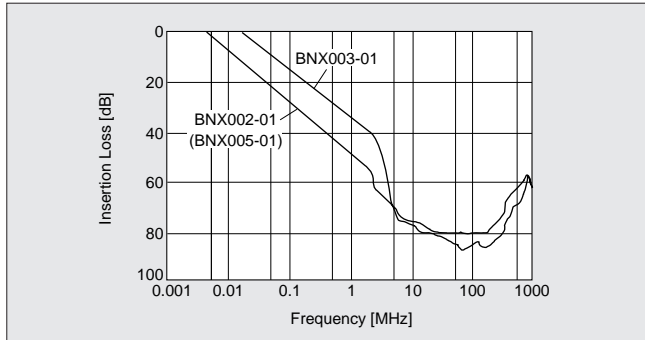

## ■ EQUIVALENT CIRCUIT

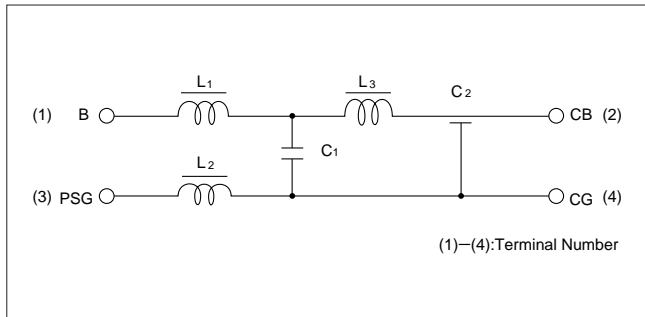

## ■ P. C. BOARD PATTERNS

Use a bilateral P. C. board. Insert the BNX into the P. C. board until the root of the terminal is secured, then solder.

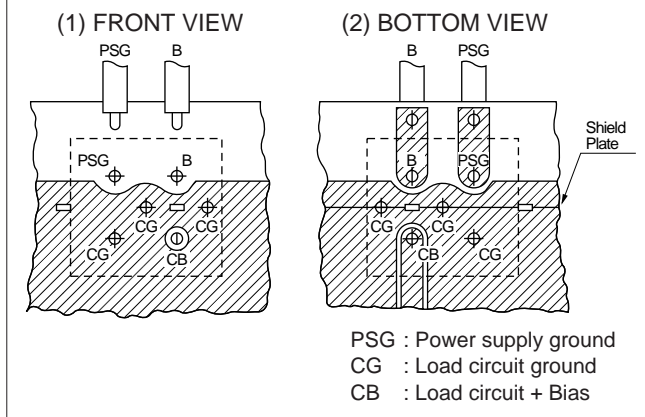

## ■ EXTERNAL DIMENSIONS

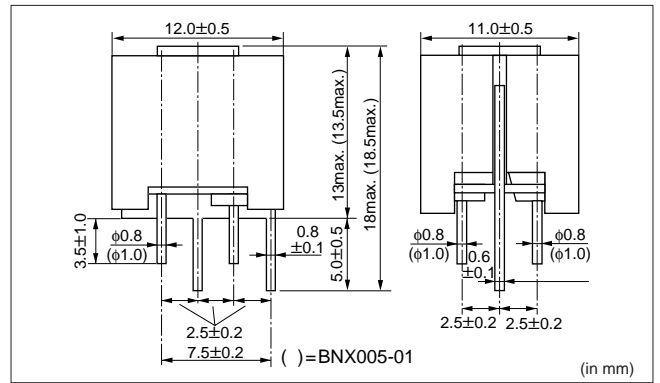

## ■ INSERTION LOSS MEASURING CIRCUIT

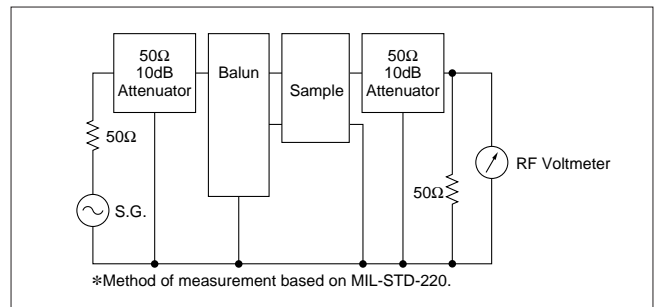

## ■ TERMINAL LAYOUT (BOTTOM FIGURE)

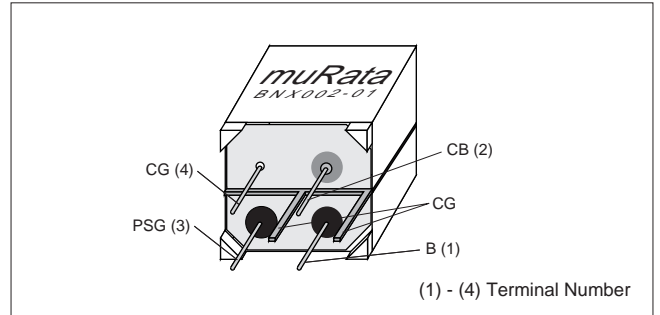

## ■ DIMENSIONS OF INSTALLATION HOLES

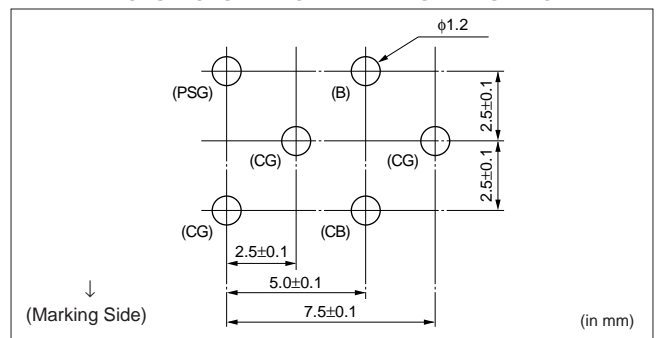

## ■ APPLICATION CIRCUIT OF BNX SERIES

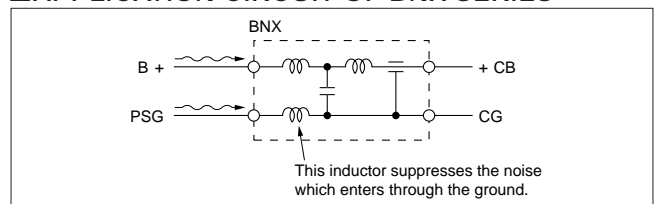

## Method of using the BNP and BNX filter blocks, and applications.

www.DataSheet4U.com

### ■USING EMIFIL® EFFECTIVELY

The block type EMIFIL® effectively prevents unwanted reflections and external noise from entering the equipment circuitry and power lines by grounding all the high frequency components which make up the noise.

Therefore, if grounding is improperly done, the filters may be unable to achieve the performance they are capable of. To prevent this, be sure to observe the following instructions.

1. When designing the P.C. board, use all the available grounding terminals, and arrange the grounding circuit so that the area of the foil for the grounding circuit is maximized.
2. Minimize the distance between the P.C. board ground and the filter's grounding plate. Use of through-hole P.C. boards.
3. Whichever P.C. board is used, push the filter into the P.C. board up to the terminal roots.
4. Do not connect PSG to CG by any other means except through the filter.

### ■APPLICATION 1

- Suppression of DC side ripple of the switching power supply

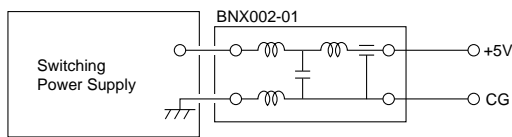

- When BNX002 is not used

(High frequency noise, max. 0.5V, can be seen.)

+5.0V →  
50μs/DIV  
0.2V/DIV

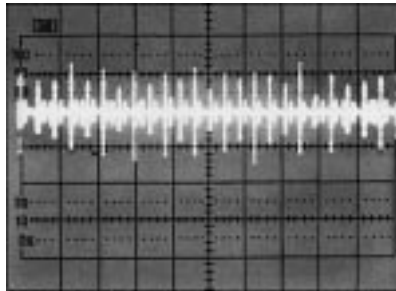

- When BNX002 is used

(Noise can be almost suppressed by BNX002.)

+5.0V →  
50μs/DIV  
0.2V/DIV

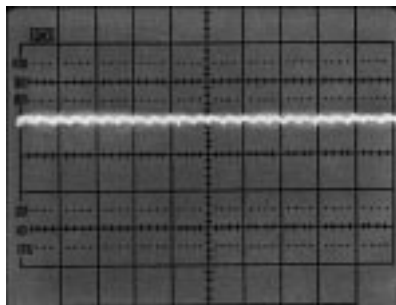

### ■PART NUMBERING

(Please specify the part number when ordering.)

(Ex.) **BNP** **002** - **02**

① ② ③

- ① Type : BNP—BNP Series  
: BNX—BNX Series
- ② Construction : The series number shows the circuit construction or the filter characteristics.
- ③ Number of Circuits : Shows the number of circuits, which are constructed one product.

3

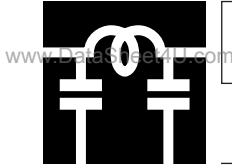

# EMI SUPPRESSION FILTERS

EMIFIL® is the trademark of Murata Manufacturing Co., Ltd.



## DC Common Mode Choke Coil **PLT/PLT09H** Series

### Compact, Light Weight, Common Mode Choke Coil for DC Power Supplies for Common Mode Noise Suppression for Several MHz to Several Hundred MHz

The PLT/PLT09H series DC common mode choke coils are EMI suppression filters that are effective against the common mode noise that can cause radiative noise in power supply lines and interface lines.

Unlike capacitor-based filters, these choke coils do not require a grounding terminal, making them applicable in situations where a stable ground cannot be obtained.

#### PLT

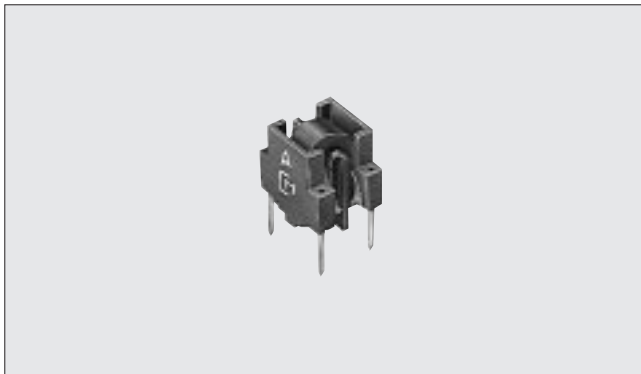

#### PLT09H

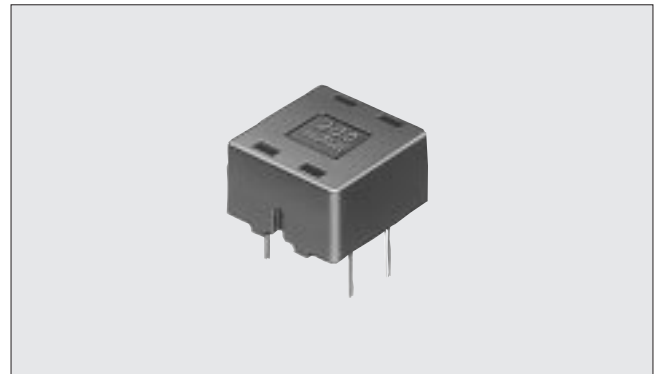

#### ■FEATURES

1. The high degree of coupling enables effective suppression of common mode noise without appreciably altering the normal mode signal waveforms even when the signal and noise frequencies are close to each other.
2. Small footprint type.

#### ■FEATURES

1. This is a wide frequency range type, applicable in applications ranging from a few MHz to several 100 MHz.
2. It features a low-profile design.

#### ■APPLICATIONS

- For suppressing noise radiation from interface cables of digital equipment such as computers and computer peripherals.
- For suppressing noise radiation from the power supply cords of digital equipment that uses AC adapters.

#### ■DIMENSIONS

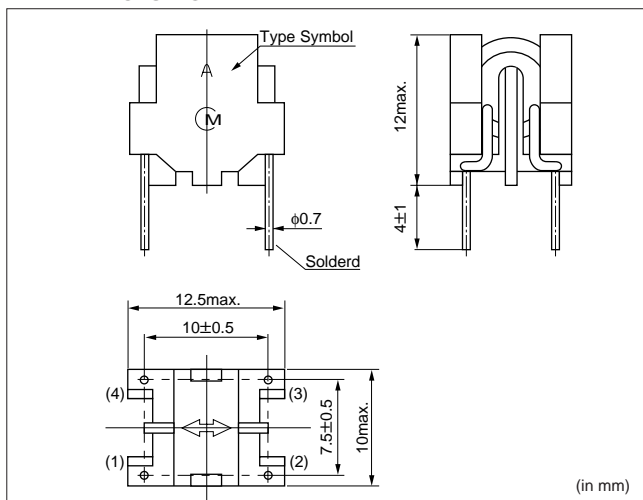

#### ■DIMENSIONS

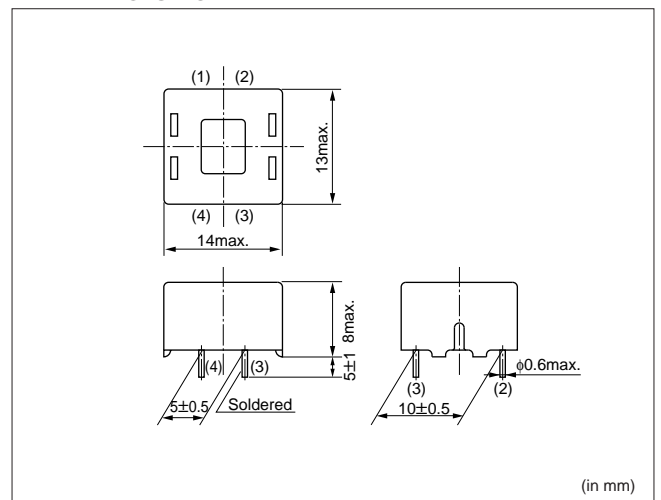

**■ RATINGS**

Item	Rating	
Rated Voltage	50Vdc	
Withstand Voltage (between coils)	125Vdc	
Insulation Resistance (between coils)	10MΩ min.	
Operating Temp. Range	PLT	-25°C to +60°C
	PLT09H	-40°C to +85°C

**■ SPECIFICATIONS**

Part Number	Inductance (μH min.)	Rated Current (A)	Code
PLT0R53C	0.5	3	B
PLT1R53C	1.5		A
PLT2003C	20		C
PLT09H-2003R	20		-

**■ PART NUMBERING**

(Please specify the part number when ordering.)



- ① Type
- ② Inductance
- ③ Rated Current
- ④ Style

**■ INSERTION LOSS CHARACTERISTICS**

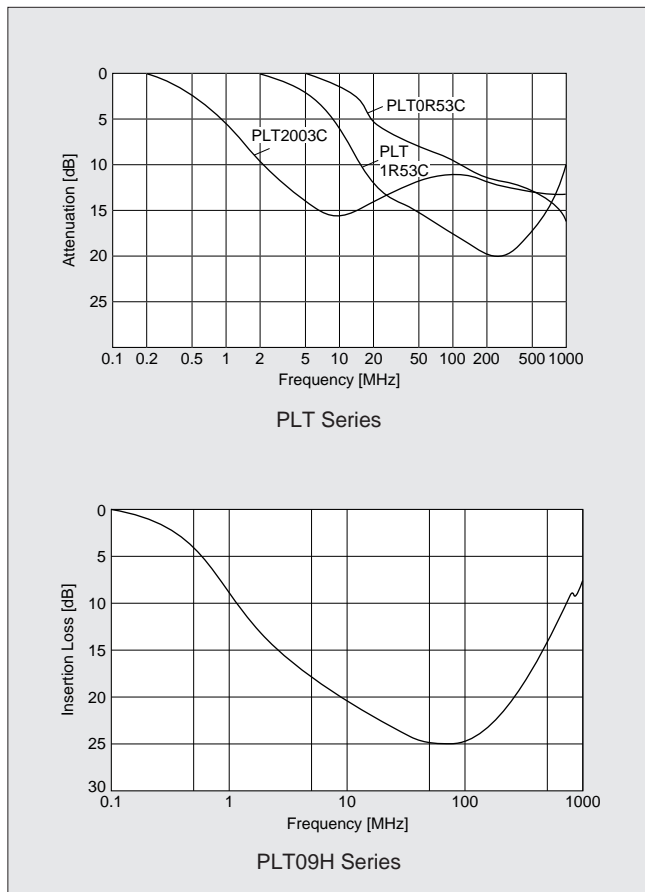

**■ CIRCUIT DIAGRAM**

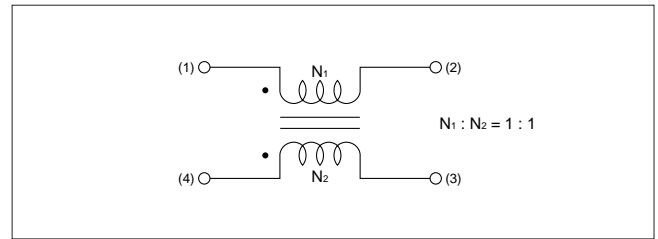

**■ EXAMPLES OF APPLICATION**

1. Suppression of noise radiating from cables between AC adaptor and main set.

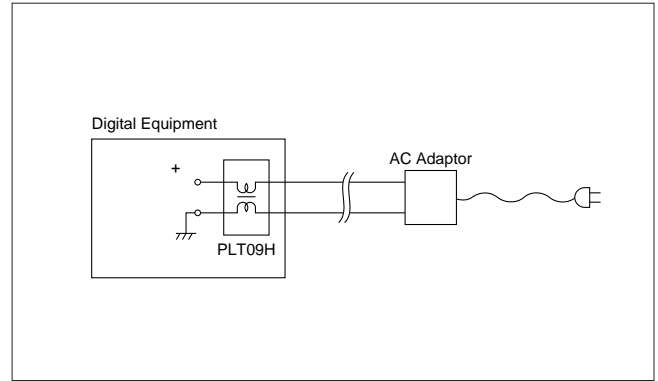

2. Suppression of noise radiating from DC power lines and interface cables.

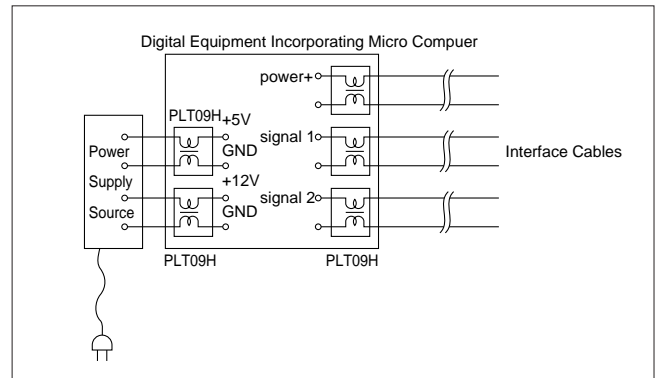

**■ USING EMIFIL® EFFECTIVELY**

To prevent degradation of the noise-suppression effect caused by an imbalance in current, be sure that the reciprocating current is equivalent on each side.

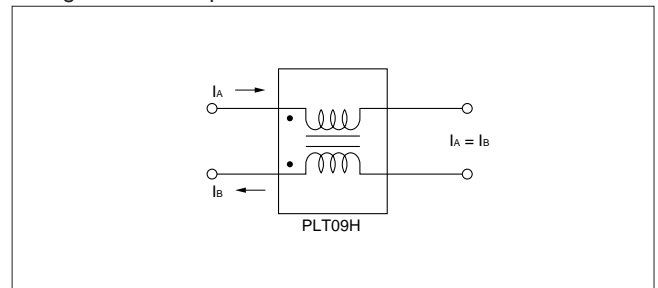

## Notice of Lead Type EMIFIL®

www.DataSheet4U.com

### ■ ⚠ CAUTION

- Rated current/Rated voltage
  - Don't use products beyond the rated current and the rated voltage, or, a fire may result due to the deterioration of the insulation resistance, excessive heat, etc.
- Mounting holes should be designed as specified in this specifications. Or different design from this specifications may cause cracks in ceramics which may lead to smoking/firing.

### ■ NOTICE

- Soldering
  - Rosin-based flux is to be used. Do not use strong acidic flux with halide content exceeding 0.2wt% (chlorine conversion value).
  - When soldering, do not exceed 5 seconds and keep 240 to 260°C
  - When soldering, avoid mechanical stress to main body or lead wire terminal product.
- Cleaning
  - Do not clean VFR303, PLT09H, and DSS706 series.
  - Clean other parts on following condition.
    - Cleaning Temperature: 60°C max.(40°C max. for CFC alternatives and alcohol cleaning agents).
    - Ultrasonic
      - Output : 20W/ ℓ max.
      - Duration : 5 minutes max.
      - Frequency : 28kHz to 40kHz
    - Cleaning agent
 

The following list of cleaning agents have been tested on the individual components. Evaluation of final assembly should be completed prior to production.

      - CFC alternatives and alcohol cleaning agents.
        - Isopropyl alcohol (IPA)
        - HCFC-225
      - Aqueous cleaning agent
        - (PLT series cannot be cleaned)
        - Surface active agent (Clean Thru 750H)
        - Hydrocarbon (Techno Cleaner 335)
        - High grade alcohol (Pine Alpha ST-100S)
        - Alkaline saponifier (Aqua Cleaner 240-cleaner should be diluted within 20% using deionized water).
  - Ensure that flux residue is completely removed. Component should be thoroughly dried after aqueous agent has been removed with deionized water.
  - Some products may become slightly whitened. However, product performance or usage is not affected.

For additional cleaning methods, please contact Murata engineering.

- Operating Environment
  - Do not use products in corrosive gas such as chlorine gas, acid or sulfide gas.
  - Do not use products near water, oil or organic solvents, Avoid environments where dust or dirt may adhere to product.

### 4. EMIGUARD®

- VFR303 series is designed only to absorb electrostatic surges. Do not use this product to absorb large energy surges such as lighting or switching related surges.
- In ESD test with VFR303, do not use in the conditions exceeding next conditions.

$$n \cdot \left\{ \frac{C}{R} V^2 \right\} < 8.0 \times 10^5$$

n : Number of ESD injection

C : Charge/Discharge Capacitance (pF)

R : Discharge Resister (Ω)

V : Test Voltage (kV)

### 5. Storage and Handling Requirements

- Storage conditions
  - Storage temperature : -10 to +40°C
  - Relative humidity : 30 to 70%
  - Avoid sudden changes in temperature and humidity.
- Do not store products in corrosive gas such as chlorine gas, acid or sulfide gas.



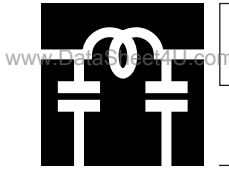

# EMC ABSORBER



## EMC absorber EA10/20/21 Series

# Suitable for Micro Wave Absorbing Wide Range from 100MHz to 20GHz Thin and Flexible Type EMC Absorber

### FEATURES

- EA10xx Series
  1. Excellent elasticity and durability with silicon rubber.
  2. Suitable for prevention abnormal oscillation in high frequency module, suppression suprious spectra and interference between circuits.
  3. Holding easily in equipments with adhesive tape.
  4. EA10xx series : UL94V-0 conformity.
- EA20xx/21xx Series
  1. High- $\mu$  and High-loss characteristics with magnetically shielded can suppress noise in wide frequency band for digital equipments.
  2. Thin (0.2mm-1.0mm) and flexible sheet makes easy handling in assembly process.
  3. Holding easily in equipments with adhesive tape.
  4. EA20xx series : Non Halogen type.  
EA21xx series : UL94V-0 conformity.

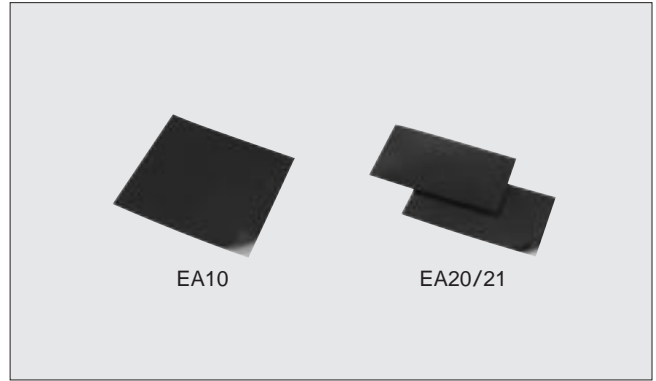

### RATING

Part Number	Application Frequency (GHz)	Thickness (mm)
EA1026A100	20.0	1.0
EA1026A160	11.5	1.6
EA1026A180	10.0	1.8
EA1046A180	5.8	1.8
EA1075A270	2.5	2.7

Part Number	Application Frequency (GHz)	Thickness (mm)
EA2070B020	0.1 to 3.0	0.2
EA2070A050		0.5
EA2070A100		1.0
EA2100B020	0.1 to 3.0	0.2
EA2100A050		0.5
EA2100A100		1.0

### REFLECTION LOSS (Typ.)

EA10 Series

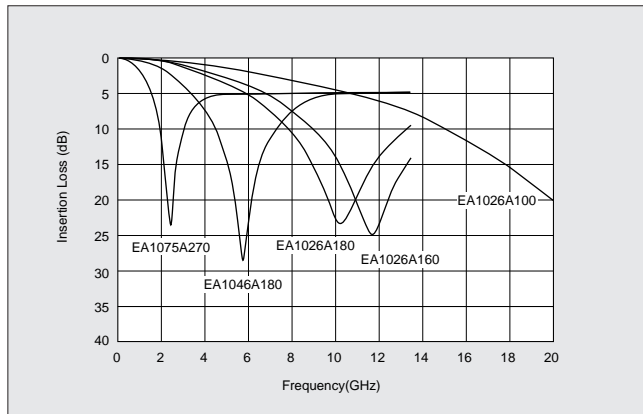

### MAGNETIC PERMEABILITY-RELUCTANCE (Typ.)

EA20/21 Series

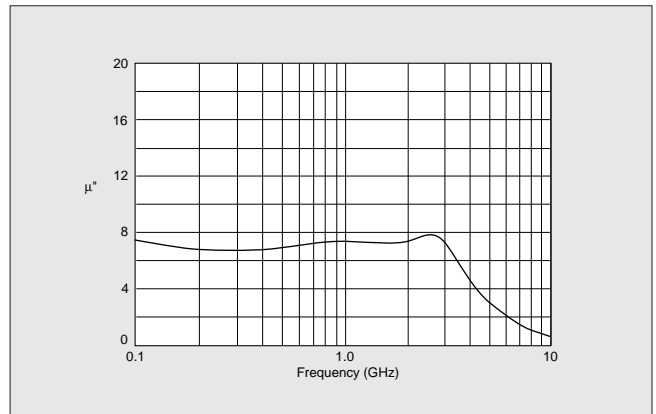

4

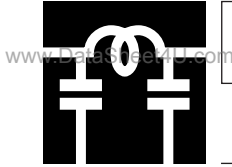

# EMI SUPPRESSION FILTERS



## EMI Suppression Filter Design Kits **EK115E/EK015D**

### ■EMIFIL® Design Kit EK115E/015D

The EMI suppression filter design kit EK115E/015D has each of the filters in a plastic case to facilitate selection when testing the noise suppression capabilities of the EMIFIL® range.

The kit can be used equally well either on-side or in the laboratory.

(When ordering, please use the part number EK115E or EK015D.)

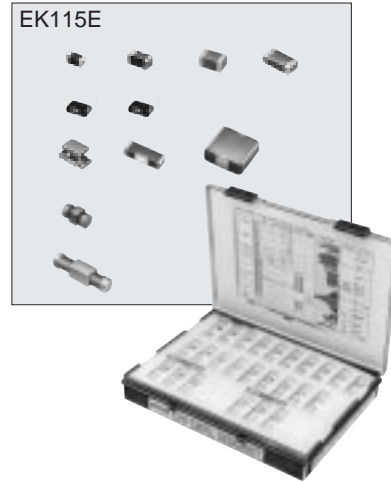

● EK115E

No.	Part Number	QTY.(pcs.)	Remark	
1	BLM11P300S	20	Chip Ferrite Bead Inductor	Small Size
2	BLM11P600S	20		Large Current
3	BLM11A121S	20		High Impedance
4	BLM11A221S	20		
5	BLM11A601S	20		
6	BLM11A102S	20		
7	BLM11B750S	20		Sharp Impedance Characteristics Suit for High-Speed Signal Line
8	BLM11B141S	20		
9	BLM11B421S	20		
10	BLM11B601S	20		
11	BLM11B102S	20		For Power Line
12	BLM11B182S	20		
13	BLM21P300S	20		
14	BLM21A121F	20		
15	BLM21A401S	20		
16	BLM21A601F	20		
17	BLM21A102F	20		
18	BLM21B050S	20		Sharp Impedance Characteristics Suit for High Speed Signal Line
19	BLM21B750S	20		
20	BLM21B201S	20		
21	BLM21B421S	20		
22	BLM21B601S	20		
23	BLM21B751SD	20		
24	BLM21B102S	20		
25	BLM21B222S	20		
26	BLM21B272S	20		For Power Line
27	BLM31P500S	20		
28	BLM41P600S	10		
29	BLM41P750S	10		
30	BLM41P800S	10		

● Continue to next page.

www.DataSheet4U.com

No.	Part Number	QTY.(pcs.)	Remark		
31	NFM39R02C220	20	Chip Solid EMIFIL®	Wide Band Noise Suppression Effect Small Size For Signal Line	
32	NFM39R02C470	20			
33	NFM39R02C101	20			
34	NFM39R12C221	20			
35	NFM39R12C471	20			
36	NFM39R12C102	20			
37	NFM39R12C222	20			
38	NFM39R12C223	20			
39	NFM41P11C204	15			For Power Line
40	NFM46P11C155	5			
41	NFM839R02C101R101	10	Chip EMIFIL® for Signal Lines	Distributed Constant Waveform Distortion Prevention	
42	NFM839R02C470R101	10			
43	NFM839R02C101R470	10			
44	NFM839R02C470R470	10			
45	NFM51R00P106	10		Steep Attenuation Characteristics Suit for High-Speed Signal Line	
46	NFM51R00P206	10			
47	NFM51R00P506	10			
48	NFM51R10P107	10			
49	NFM51R20P207	10			
50	NFM51R30P507	10			
51	NFM60R00T220	10	Small Size T-Type Chip EMIFIL®	Large Rated Current For Power Line	
52	NFM60R00T221	10			
53	NFM60R30T222	10			
54	NFM61R00T101	10	T-TypeChip EMIFIL®		
55	NFM61R00T181	10			
56	NFM61R00T361	10			
57	NFM61R10T102	10			
58	NFM61R30T472	10			

● Please use the products in this Design Kit for experiment or test production, but do not use for mass production. When using for mass production, please order them after confirming detailed specifications by approving the appropriate individual specification sheet.





● EK015D

No.	Part Number	QTY.(pcs.)	Remark		
1	BNX002-01	3	Block type EMIFIL®	for use in DC Power Line	
2	BNX003-01	3			
3	BNX005-01	3		π-type EMIFIL® for Signal Circuit	
4	BNP002-03	3			
5	BNP004-02	3			
6	BL01RN1-A62	50	Ferrite Beads Inductor	Axial-type	
7	BL02RN2-R62	50		Radial-type	
8	BL03RN2-R62	50			
9	DS306-55Y5S470M50	20	3-Terminal Capacitor	2.5mm Pitch for Automatic Insertion	
10	DS306-55Y5S101M50	20			
11	DS306-55Y5S271M50	20			
12	DS306-55Y5S102M50	20			
13	DS306-55Y5S222M50	20			
14	DS306-55FZ103Z50	20			
15	DSS306-55Y5S220M100	50			Miniature Disk Type EMIFIL®
16	DSS306-55Y5S470M100	50			
17	DSS306-55Y5S101M100	50			
18	DSS306-55Y5S221M100	50			
19	DSS306-55Y5S471M100	50			
20	DSS306-55Y5S102M100	50			
21	DSS306-55Y5U222Z100	50			
22	DSS306-55FZ103N100	50			
23	DSS306-55F223Z16	50			
24	DS310-55Y5S223S50	20		Wide Band Disk-type EMIFIL® for Noise Suppression	
25	DS310-55Y5S104M16	20		Heavy Duty Disk-type EMIFIL®	
26	DSS310-55Y5S223S50	20			
27	DSS310H-55B220M250	20			
28	DDS310H-55B101M250	20		Varistor-capacitor	
29	DSS310H-55B271M250	20			
30	DSS310H-55B222M250	20			
31	DSS706-351D221M25-50	20		DC Common Mode Choke Coil	for use in DC Power Line
32	DSS710D223S12-22	5			
33	VFR303-351AY25-50	5			
34	PLT0R53C	3	DC Common Mode Choke Coil	for use in DC Power Line	
35	PLT1R53C	3			
36	PLT09H-2003R	3			

● Please use the products in this Design Kit for experiment or test production, but do not use for mass production. when using for mass production, please order them after confirming detailed specifications by approving the appropriate individual specification sheet.

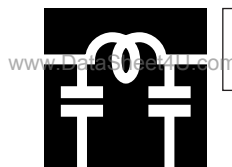

# EMI SUPPRESSION FILTERS



## Chip EMI Suppression Filter Design Kits

### <Design Kit for individual series>

Part Number	Contents
EKEM11UB (BLM Standard type)	BLM11A/11B/11P/11HA/11HB/21P/31P/41P, BLA3216A/3216B Series
EKEM12UC (NFM Standard type)	NFM51R/839R/39R/2012P/60R/61R/ NFA3216G Series
EKEM13UA	BLM10A/10B Series
EKEM14UA	BLM21A/21B/31A/41A Series



### EKEM11UB

No.	Part Number	Qty.
1	BLM11A121S	20
2	BLM11A221S	20
3	BLM11A471SG	20
4	BLM11A601S	20
5	BLM11A102S	20
6	BLM11B050SA	20
7	BLM11B100SA	20
8	BLM11B220SA	20
9	BLM11B470SA	20
10	BLM11B750SA	20
11	BLM11B121SA	20
12	BLM11B100SB	20
13	BLM11B220SB	20
14	BLM11B470SB	20
15	BLM11B600SB	20
16	BLM11B121SB	20
17	BLM11B221SB	20
18	BLM11B471SB	20
19	BLM11B121SD	20
20	BLM11B221SD	20
21	BLM11B471SD	20
22	BLM11B601S	20
23	BLM11B102S	20
24	BLM11B182S	20
25	BLM11B252SD	20
26	BLM11HA471SG	20
27	BLM11HA601SG	20
28	BLM11HA102SG	20
29	BLM11HB471SD	20
30	BLM11HB601SD	20

No.	Part Number	Qty.
31	BLM11HB102SD	20
32	BLA3216A121SG4	20
33	BLA3216A221SG4	20
34	BLA3216A601SG4	20
35	BLA3216A102SG4	20
36	BLA3216B121SD4	20
37	BLA3216B471SD4	20
38	BLA3216B601SD4	20
39	BLM11P300S	20
40	BLM11P600S	20
41	BLM21P300S	20
42	BLM21P221SG	20
43	BLM21P331SG	20
44	BLM31P330SG	20
45	BLM31P121SG	20
46	BLM31P391SG	20
47	BLM31P601SG	20
48	BLM41P600S	20
49	BLM41P750S	20
50	BLM41P181SG	20
51	BLM41P471SG	20
52	BLM41P102SG	20

● Please use the products in this Design Kit for experiment or test production, but do not use for mass production.  
When using for mass production, please order them after confirming detailed specifications by approving the appropriate individual specification sheet.



## EKEM12UC

No.	Part Number	Qty.
1	NFM51R00P106	20
2	NFM51R00P206	20
3	NFM51R00P506	20
4	NFM51R10P107	20
5	NFM51R20P207	20
6	NFM51R30P507	20
7	NFM839R02C100R220	20
8	NFM839R02C100R470	20
9	NFM839R02C470R220	20
10	NFM839R02C470R470	20
11	NFM839R02C470R680	20
12	NFM839R02C470R101	20
13	NFM839R02C101R220	20
14	NFM839R02C101R470	20
15	NFM839R02C101R680	20
16	NFM839R02C101R101	20
17	NFM39R02C220	20
18	NFM39R02C470	20
19	NFM39R02C101	20
20	NFM39R12C221	20
21	NFM39R12C471	20
22	NFM39R12C102	20
23	NFM39R12C222	20
24	NFM39R12C223	20
25	NFM2012P13C104R	20
26	NFM2012P13C474F	20
27	NFM60R00T220	20
28	NFM60R00T470	20
29	NFM60R00T101	20
30	NFM60R00T221	20
31	NFM60R10T471	20
32	NFM60R20T152	20
33	NFM60R30T222	20
34	NFM61R00T681	20
35	NFM61R10T102	20
36	NFM61R30T472	20
37	NFA3216G2C100R6R8	20
38	NFA3216G2C100R470	20
39	NFA3216G2C100R101	20
40	NFA3216G2C470R6R8	20
41	NFA3216G2C470R470	20
42	NFA3216G2C470R101	20
43	NFA3216G2C101R6R8	20
44	NFA3216G2C101R470	20
45	NFA3216G2C101R101	20

## EKEM13UA

No.	Part Number	Qty.
1	BLM10A100S	20
2	BLM10A700S	20
3	BLM10A121S	20
4	BLM10A221SG	20
5	BLM10A601SG	20
6	BLM10A102SG	20
7	BLM10B750SB	20
8	BLM10B121SB	20
9	BLM10B221SB	20
10	BLM10B421SD	20
11	BLM10B601SD	20
12	BLM10B102SD	20

## EKEM14UA

No.	Part Number	Qty.
1	BLM21A121F	20
2	BLM21A221SG	20
3	BLM21A471SG	20
4	BLM21A601S	20
5	BLM21A102S	20
6	BLM21B600SB	20
7	BLM21B750S	20
8	BLM21B121SB	20
9	BLM21B221SB	20
10	BLM21B471SB	20
11	BLM21B121SD	20
12	BLM21B221SD	20
13	BLM21B471SD	20
14	BLM21B601S	20
15	BLM21B102S	20
16	BLM21B182SD	20
17	BLM21B222S	20
18	BLM21B272S	20
19	BLM31A700S	20
20	BLM31A601S	20
21	BLM41A800S	20
22	BLM41A151S	20

**Outlines of Major Noise Regulation Standards**

www.DataSheet4U.com

**1. EMI Regulations**

Equipment		Countries	Information Regulation	Japan	USA	Europe
Emission	Generic Standard		IEC61000-6-3 IEC61000-6-4			EN50081-1 EN50081-2
	ITE : Information Technology Equipment Printer, Personal computer Word processor, Display		CISPR Pub. 22	VCCI Electrical Appliance Regulation	FCC Part 15 Subpart B	EN55022
	ISM equipment Microwave		CISPR Pub. 11	Electrical Appliance Regulation	ECC Part 18	EN55011
	Igniter (Automobile, Motorboat)		CISPR Pub.12	JASO	FCC Part 15 Subpart B	Automotive Directive
	TV, Radio, Audio, VTR		CISPR Pub.13	Electrical Appliance Regulation	Fcc Part 15 Subpart B	EN55013
	Household electrical equipment Portable tool		CISPR Pub.14	Electrical Appliance Regulation		EN55014
	Fluorescent Lamp Luminary		CISPR Pub.15	Electrical Appliance Regulation		EN55015
	Transceiver		CCIR	Radio Act	FCC Part 15 Subpart C FCC Part 22	ETS300 Series
	Power Supply Higher Harmonte		IEC555 IEC61000-3	Industrial Voluntary Regulation		EN60555 EN61000-3
	Immunity	Basic Standard		IEC61000-4	In the process of Regulating at JIS	
Generic Standard			IEC61000-6-1 IEC61000-6-2	In the process of Regulating at JIS		EN50082-1 EN50082-2
Industrial Process Measurement and Control Equipment			IEC801 Series	Industrial Voluntary Action		
Radio, TV			CISPR Pub. 20			EN55020
ITE : Information Technology Equipment			CISPR Pub. 24			EN55024

There are EMI regulation in each country to meet EMI noise level emitted from digital equipment.  
In the countries which regulates EMI, equipments which do not satisfy with regulations are not allowed to be sold.







## Outlines of Major Noise Regulation Standards

www.DataSheet4U.com

### Scope of CISPR Pub.22 Regulation

This regulation applies to information technology equipment (ITE) which are defined as :

- (a) Equipment that receive data from external signal sources ;
- (b) Equipment that processes received data ;
- (c) Equipment that output data
- (d) Equipment that has less than 600V rated voltage in power supply

#### CISPR Regulations

- Pub.10 Organization, Regulations and Procedures of CISPR
- Pub.11 Industrial, Scientific and Medical (ISM) Radio-Frequency Equipment
- Pub.12 Vehicles, Motor Boats and Spark-Ignited Enginedriven

- Pub.13 Sound and Television Receivers
- Pub.14 Household Electrical Appliances, Portable Tools and Similar Electrical Apparatus
- Pub.15 Fluorescent Lamps and luminaries
- Pub.16 Radio Interference Measuring Apparatus and Measurement Methods
- Pub.17 Passive Radio Interference Filters and Suppression Components
- Pub.18 Power Transmission Cables and High Voltage Equipments
- Pub.19 Microwave Ovens for Frequencies above 1GHz
- Pub.20 Immunity of Sound and TV Broadcast Receivers Veceivers and Associated Equipment
- Pub.21 Interference to Mobile Radiocommunications in the Presence of Impulsive Noise
- Pub.22 Information Technology Equipment
- Pub.23 Industrial Scientific and Medical (ISM) Equipment
- Pub.24 Immunity Regulation of Information Technology Equipment

### 4. Limits of VCCI Voluntary Regulation

Mains Terminal Interference Voltage (Power Supply)

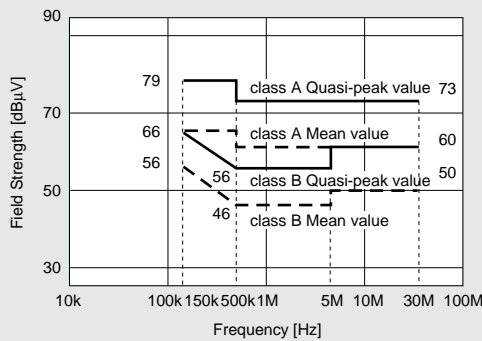

Radiated Interference

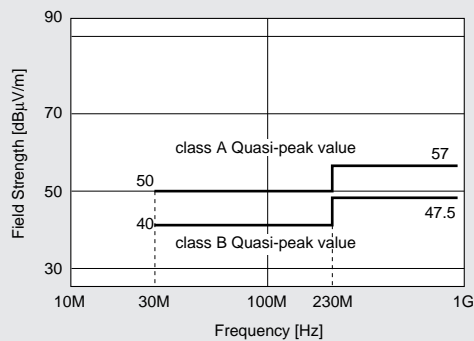

On the border frequency, lower limit shall be applied.

- Class B ITE : Equipment that designed to be used at home.
- Class A ITE : Equipment that does not meet interference limit of class B equipment. However satisfying interference limit of class A equipment.

VCCI recommend measurement at 10m distance. 3m or 30m distance measurement are also allowed.

Main Terminal Interference Voltage of 150kHz to 526.5kHz.

- From 1999 April, New products shall be applied with easing 10dB.
- From 2001 April, New products shall be applied with easing 0dB.

### Scope of VCCI Voluntary Regulation

This regulation applies to information technology equipment (same as CISPR Pub.22), but the application is excluded on the following equipments :

- Equipment for which other regulations already exist (e.g., household electrical appliances, radio and TV receivers)
- In station equipment principal purpose of which is electrical communication
- Industrial plant control system for which information processing is a secondary system function
- Industrial, commercial and medical testing and measuring systems for which data processing is a secondary system function

- Information equipment for which CISPR is conducting further deliberation
- VCCI is the acronym of Voluntary Control Council for Interference by Data Processing Equipment and Electronic Office Machines.
- VCCI is organized by the following organizations :
- Japan Electronic Industry Development Association (JEIDA)
  - Japan Business Machine Makers Association (JBMA)
  - Electronic Industries Association of Japan (EIAJ)
  - Communication Industries Association of Japan (CIAJ)

## Outlines of Major Noise Regulation Standards

www.DataSheet4U.com

### 5. Limits of FCC Part 15 Subpart B

Mains Terminal Interference Voltage (Power Supply)

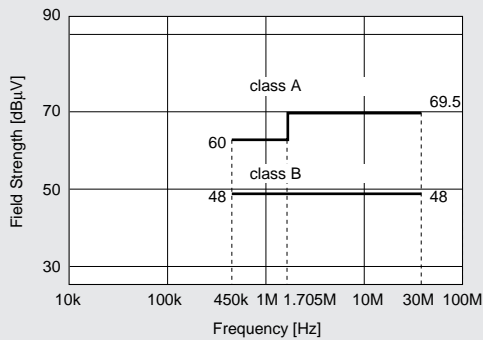

**Class A Equipment :** The digital equipment that is sold to in the commercial, industrial and office use.

**Class B Equipment :** The digital equipment that is sold to be used in residential area.

Class A recommend to be measured with 10m distance.

Class A recommend to be measured with 3m distance.

Radiated Interference

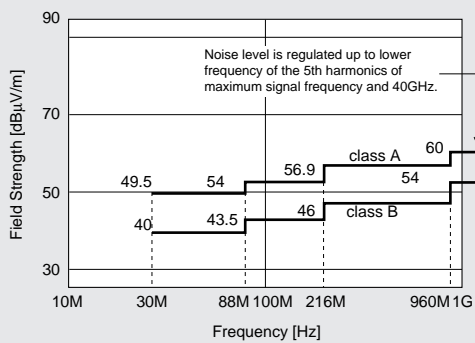

On the border frequency, lower limit shall be applied.

- The FCC Part 15 regulation controls radiated interference by establishing quasi-peak and mean value limits for frequencies ranging from 30MHz to 40GHz (or maximum frequency's fifth harmonic, whichever is lower).
- For AC main ports, the FCC Part 15 regulation controls mains terminal interference voltage by establishing quasi-peak value limits for frequencies ranging from 450kHz to 30MHz.
- There is no regulation on interference power.

#### FCC Regulations

Part 1 Procedures

Part 2 Frequency Division and Radio Wave Treaty Issues and General Rules

Part 15 Radio Wave Equipment

- Intentionally electromagnetic radiation equipment
- Non-intentionally electromagnetic radiation equipment
- Incidentally electromagnetic radiation equipment

Part 18 Industrial, Scientific and Medical Equipment

Part 22 Public Mobile Wireless Operations

Part 68 Connecting Terminal Equipment to Telephone Circuit Network

Part 76 Cable Television

Measurement Frequency Range for Radiated Interference

Maximum Frequency the Equipment Internally Generates, Uses or Operates or Synchronizes (MHz)	Upper End of Measurement Frequency Range
Less than 1.705	30
1.705 to 108	1000
108 to 500	2000
500 to 1000	5000
Over 1000	Maximum Frequency's Fifth Harmonic or 40GHz, Whichever is Lower

## Outlines of Major Noise Regulation Standards

www.DataSheet4U.com

### 6. Immunity Regulations in Europe Union

All products which are sold in EU must satisfy EC directive which contains immunity regulation.

Principal EC Directive	
EMC Directive	89/336/EEC 92/31/EEC
Low-Voltage Electrical Products Directive	73/23/EEC
Machines Directive	89/392/EEC

All electric/electronic equipment cannot be sold in Europe without CE marking. To use CE marking, they must satisfy related EC directive such as EMC directive.

In EMC directive, EMI regulations are integrated, and immunity regulations are applied. Although these immunity regulations are prepared by CENELEC, almost all contents are same as standards issued by IEC or CISPR.

Noise regulations in EU is prepared by CENELEC. Their contents are almost same as IEC or CISPR regulations.

Standard	Application	IEC	CISPR	CENELEC
Basic Standard		IEC61000-4		EN61000-4
Generic Standard		Residential, Commercial and Light Industry In the process of IEC61000-6-1 (IEC61000-6-3)		Residential, Commercial and Light Industry EN50082-1 (EN50081-1)
		Industrial In the process of IEC61000-6-2 (IEC61000-6-4)		Industrial EN50082-2 (EN50081-2)
Product Family Standard	Radio, TV		CISPR Pub. 20 (CISPR Pub. 13)	EN55020 (EN55013)
	Information Technology Equipment		CISPR Pub. 24 (CISPR Pub. 22)	EN55024 (EN55022)
Product Standard				

Standards in bracket are Emission Standards.

**Noise Suppression Principles by DC EMIFIL®**

www.DataSheet4U.com

● **Function of DC EMI Suppression Filters**

DC EMI suppression filters absorb and eliminate high frequency noise which may produce electromagnetic interference in PC board circuits.

These filters are used in secondary circuits, and are small in size and light in weight, which further enhances their excellent noise suppression functions.

Chip and adhesive type filters can be mounted on PC boards automatically.

These filters are effective in the suppression of radiation noise in computers, peripheral equipment, and digital circuit application equipment (including various types of microcomputer application equipment), and function to suppress noise in audio/visual equipment, which uses digital memory chips and DSP.

These filters are also effective for improving the noise immunity of equipment used in noisy environments (such as electronic equipment for automobiles).

● **Noise Filter Suppression Principles**

Generally, noise problems occur when the noise source and electronic equipment sensitive to the influence of noise are located in close proximity to one another.

In such situations, as shown in Fig.A below, noise is conducted through a conductor, which produces an inductive field around the noise source.

To overcome such noise problems, it is preferable to reduce the amount of noise generated by the noise source or improve the noise resistance of adjacent equipment.

In order to satisfy equipment performance specifications and eliminate noise effectively at the same time, however, it is customary to reduce the amount of noise generated by the noise source, if it can't be eliminated altogether.

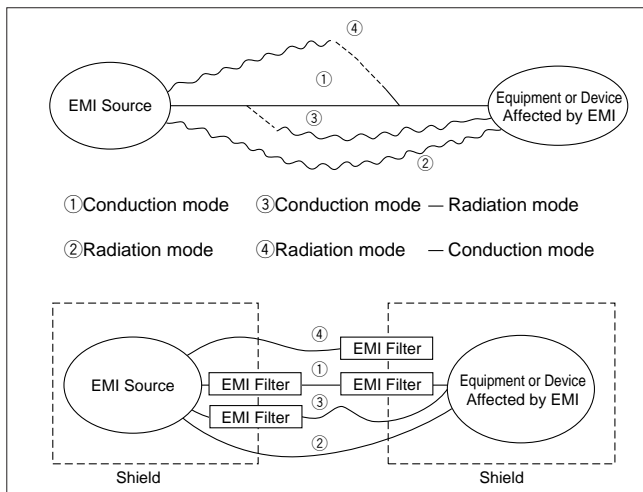

Fig.A EMI Propagation Mode and Model of Noise Filter Suppression

● **Configuration of EMI Suppression Filters (DC)**

DC EMI suppression filters are used to suppress noise produced by conductors. Noise radiation can be suppressed, if it is eliminated with a filter in advance.

Generally, such noise suppression is achieved with DC EMI suppression filters, according to the capacitive and inductive frequency characteristics of the respective conductors in the circuit.

Filters of this kind can be roughly divided into those :

- (1) employing a capacitor,
- (2) employing an inductor,
- (3) employing a capacitor and inductor combination.

● **Capacitive Noise Suppression**

When a capacitor is connected (bypass capacitor) to ground from a noisy signal line or power line, the circuit impedance decreases as the frequency increases. Since noise is a high frequency phenomenon, it flows to ground if a capacitor has been connected to ground, thereby making it possible to eliminate noise. (See Fig. B below.)

EMI suppression filters employing a capacitor in this way are used to eliminate this type of noise.

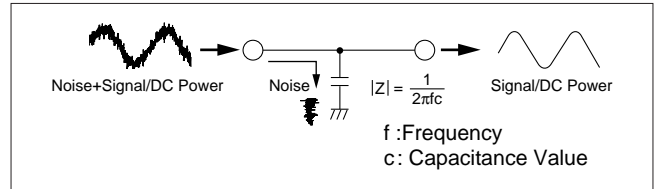

Fig.B Capacitive Noise Suppression

● **High frequency Capacitor Characteristics Used for EMI Suppression Filters**

Even general-purpose capacitors can be used for noise suppression. However, since noise has an extremely high frequency range, general-purpose capacitors may not function as effective bypass capacitors, due to the large residual inductance built into the capacitor.

All the capacitors used in MURATA's EMI suppression filters employ a 3 terminal structure or thru-type structure, which functions effectively even at high frequencies, thereby minimizing the influence of residual inductance.

Consequently, an effective filter circuit can be formed even at frequencies exceeding 1GHz. (Refer to Fig. C below.)

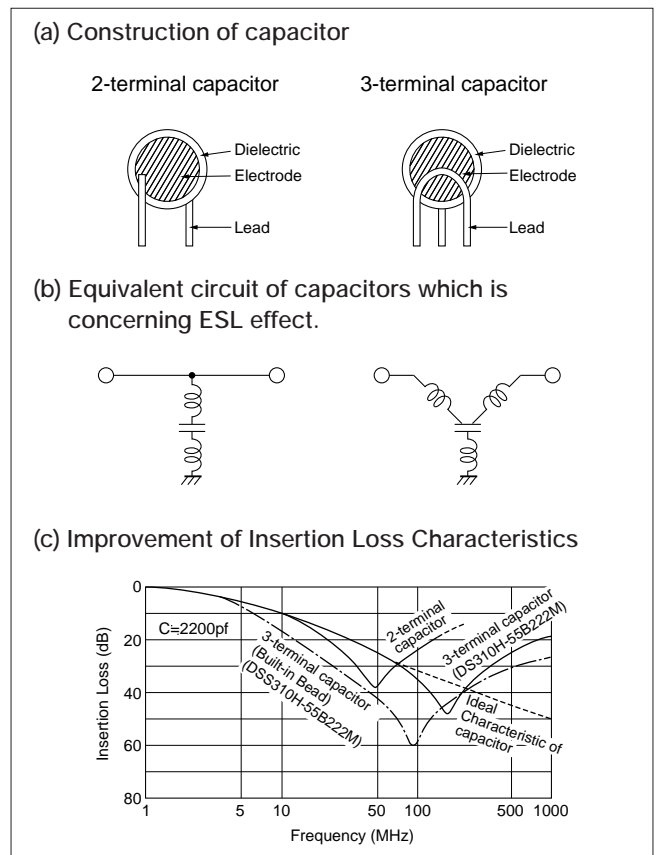

Fig.C Equivalent circuit of general-purpose capacitor and 3 terminal capacitor in the high frequency area and comparison of insertion loss

**Noise Suppression Principles by DC EMIFIL®**

www.DataSheet4U.com

● **Inductive Noise Suppression**

When an inductor is inserted in series in a noise producing circuit (See Fig.D), its impedance increases with frequency. In this configuration it is possible to attenuate and eliminate noise components (high frequency components). The MURATA EMI suppression filter functions in this way.

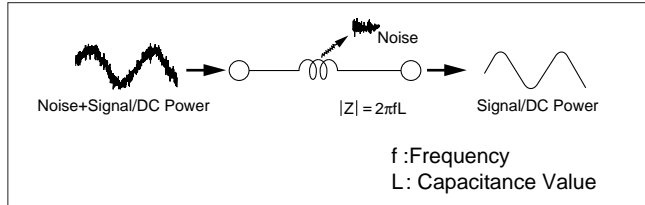

Fig.D Inductive Noise Suppression

● **Characteristics of Inductors Used in EMI Suppression Filters**

General-purpose inductors also function to suppress noise when configured in series with a noise producing circuit. However, when general-purpose inductors are used, resonance may result in peripheral circuits, signal wave forms may become distorted, and satisfactory impedance may not be obtained at noise frequencies (due to insufficient high frequency impedance characteristics).

The inductors used for MURATA's EMI suppression filters are designed to function nearly as a resistor at noise frequencies, which greatly reduces the possibility of resonance and leaves signal wave forms undistorted. And since sufficient impedance is obtained for frequencies ranging to hundreds of MHz, these specifically designed inductors operate effectively to suppress high-frequency noise. (See Fig.E)

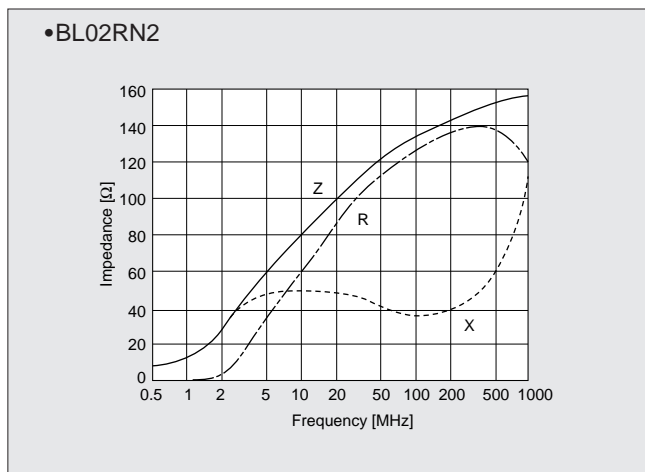
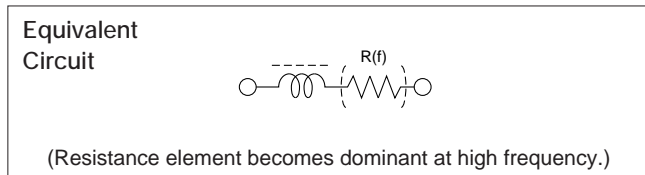

Fig.E Example of impedance frequency characteristics of inductor type EMIFIL®

● **Capacitive-Inductive EMI Suppression Filters**

If a capacitive and inductive suppression characteristics are combined, it is possible to configure a much higher performance filter. In signal circuit applications where this combination is applied, noise suppression effects which have little influence on the signal wave form become possible.

This type of filter is also effective in the suppression of high-speed signal circuit noise. When used in DC power circuits, capacitive-inductive filters prevent resonance from occurring in peripheral circuits, thus making it possible to achieve significant noise suppression under normal service conditions.

● **Other EMI Suppression Filters**

In addition to the capacitive-inductive filter, MURATA also has an EMI suppression filter (EMI-GUARD®) combining a capacitor with a varistor, useful for surge absorption; and a common mode choke coil effective, for common mode noise suppression.

MURATA also has a range of built-in filter connectors which greatly reduce filter mounting space requirements.

● **Expressing EMI Suppression Filter Effects**

EMI Suppression Filter effects are expressed in terms of the insertion loss measured in the circuit, normally specified in MIL-STD 220A. As shown in the 50Ω impedance circuit in Fig.5 below, insertion loss is represented by the logarithmic ratio of the circuit output voltage with and without a filter in the circuit, which is multiplied by 20 and expressed in dB. Therefore, an insertion loss of 20dB indicates an out put voltage ratio (B/C) of 1/10, and an insertion loss of 40dB indicates an output voltage ratio (B/C) of 1/100.

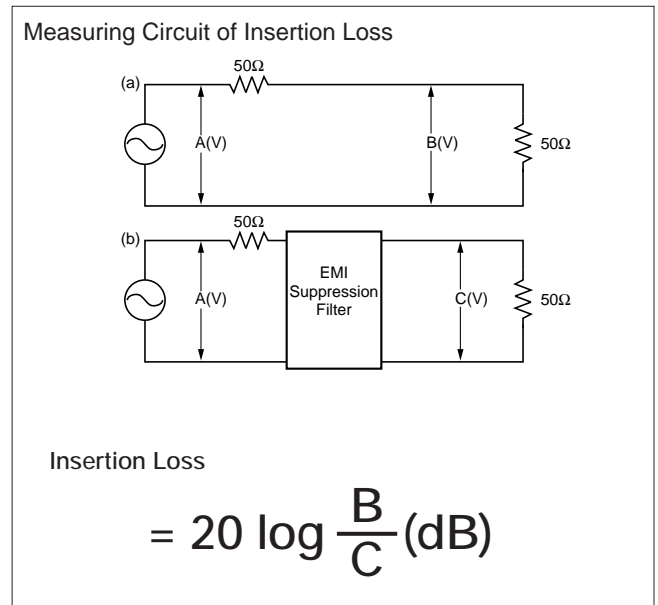

Fig.F Measuring Circuit of Insertion Loss

## Murata EMI Filter Selection Simulator

www.DataSheet4U.com

The Murata EMI Filter Selection Simulator simulates effects of Murata EMI Filters.

Simulation results are displayed with a Voltage-Waveform chart and a Spectrum-Frequency chart. The filters can be simulated under various circuit conditions.

### OPERATION

1. Enter "Input Signal" in the Simulation window.
2. Enter LCR values or select Driver IC from the pull-down list.
3. Enter the part number or select EMI Filter from the pull-down list.
4. Set Transmission Line. (Three ways can be selected.)
5. Enter LCR values or select Receiver IC from the pull-down list.
6. Click on the "Start Simulation" button.
7. Simulation results are displayed on the new window.

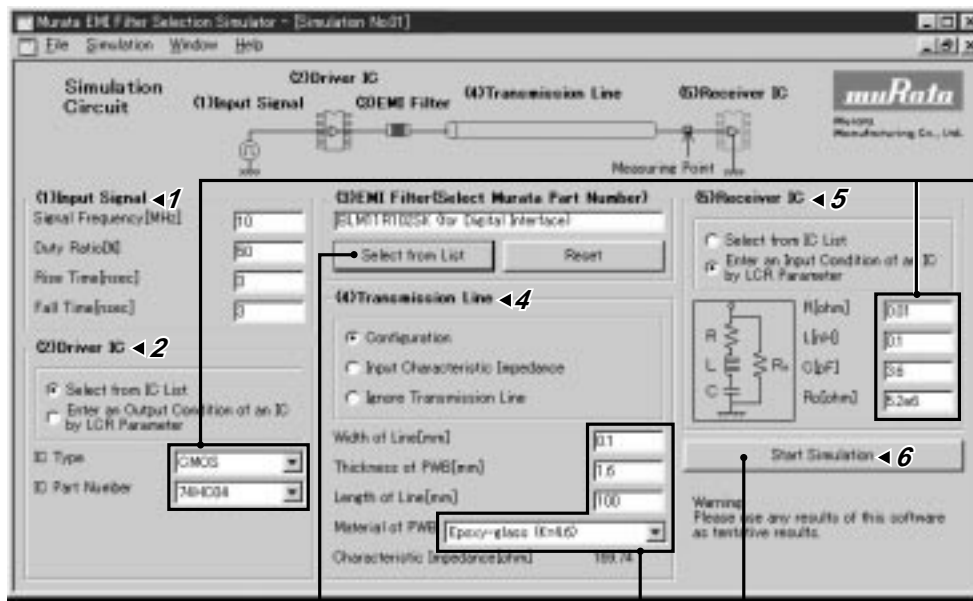

Two ways of setting the driver/receiver IC parameter.

The logic IC of TTL and CMOS can be selected from pull-down list. LCR values can also be entered.

Impedance automatically calculated.

Impedance characteristics under actual pattern are automatically calculated. (When the "Configuration" is selected.)

Voltage waveform and voltage-spectrum charts are displayed in the same window. They can also be printed and copied to clipboard.

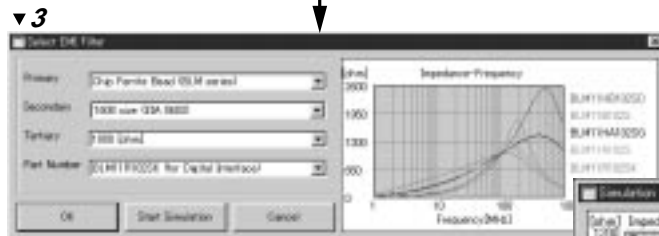

EMI filters can be selected from the "Select EMI Filter" window.

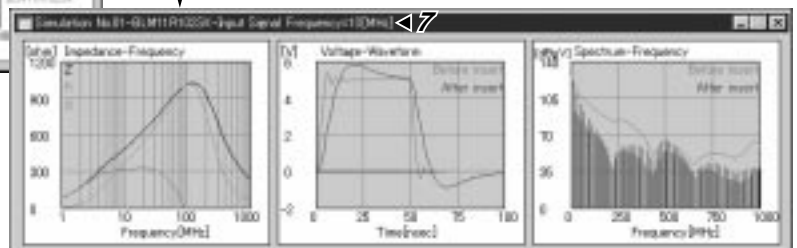

This application can be downloaded from Murata web site.

<http://www.murata.co.jp/emc/mefss.html>



**⚠ Note:****1. Export Control**

〈For customers outside Japan〉

Murata products should not be used or sold for use in the development, production, stockpiling or utilization of any conventional weapons or mass-destructive weapons (nuclear weapons, chemical or biological weapons, or missiles), or any other weapons.

〈For customers in Japan〉

For products which are controlled items subject to the "Foreign Exchange and Foreign Trade Law" of Japan, the export license specified by the law is required for export.

**2. Please contact our sales representatives or product engineers before using our products listed in this catalog for the applications listed below which require especially high reliability for the prevention of defects which might directly cause damage to the third party's life, body or property, or when intending to use one of our products for other applications than specified in this catalog.**

- ① Aircraft equipment
- ② Aerospace equipment
- ③ Undersea equipment
- ④ Power plant equipment
- ⑤ Medical equipment
- ⑥ Transportation equipment (vehicles, trains, ships, etc.)
- ⑦ Traffic signal equipment
- ⑧ Disaster prevention / crime prevention equipment
- ⑨ Data-processing equipment
- ⑩ Application of similar complexity and/or reliability requirements to the applications listed in the above

**3. Product specifications in this catalog are as of April 2000. They are subject to change or our products in it may be discontinued without advance notice. Please check with our sales representatives or product engineers before your ordering. If there are any questions, please contact our sales representatives or product engineers.****4. The parts numbers and specifications listed in this catalog are for information only. You are requested to approve our product specification or to transact the approval sheet for product specification, before your ordering.****5. Please note that unless otherwise specified, we shall assume no responsibility whatsoever for any conflict or dispute that may occur in connection with the effect of our and/or third party's intellectual property rights and other related rights in consideration of your using our products and/or information described or contained in our catalogs. In this connection, no representation shall be made to the effect that any third parties are authorized to use the rights mentioned above under licenses without our consent.****6. None of ozone depleting substances (ODS) under the Montreal Protocol is used in manufacturing process of us.**